

**Holistic Architecture  
Based on  
Living Curvation  
& Sacred Geometry  
from  
Michael Rice**

- [holisticarchitecture.com](http://holisticarchitecture.com)
- [holistichouseplans.com](http://holistichouseplans.com)



*The Michael Rice  
Holistic Architecture  
Gallery*

**For Organic Architecture  
of FEELING Spaces-  
Hex 'Fixes' (holds inside),  
Pent Sends!**

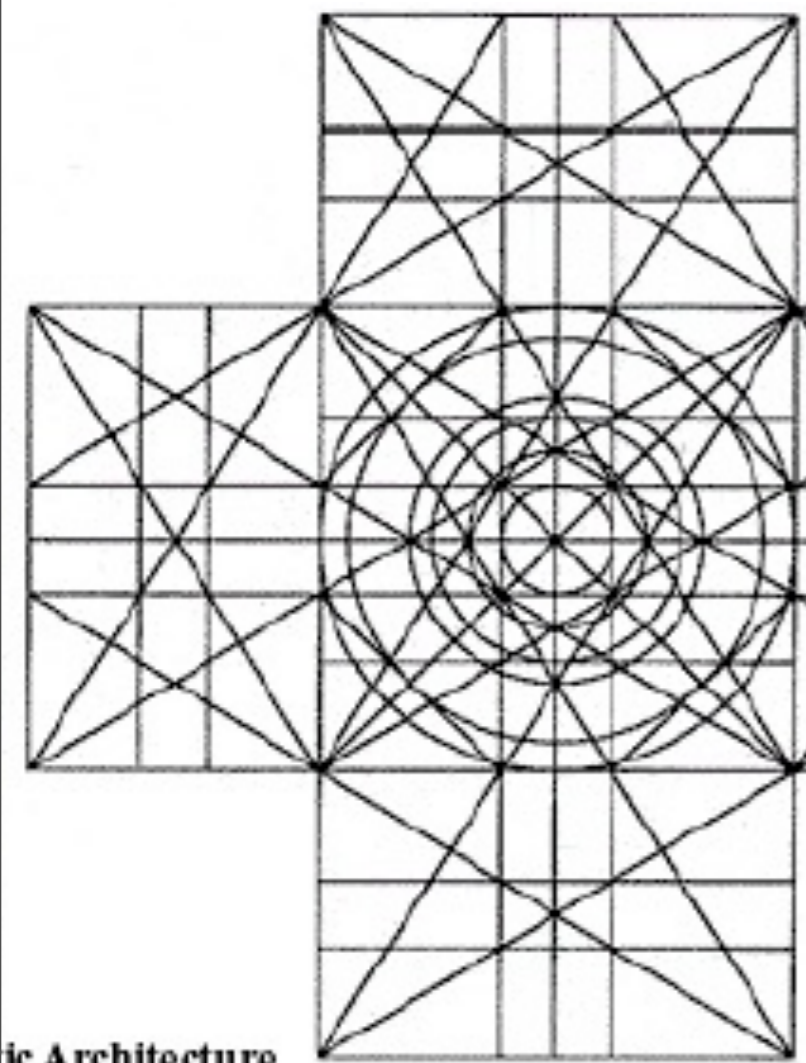

**Use log 2 edge ratios  
in privacy spaces -  
use log Phi edge ratios  
in public /projective spaces.**

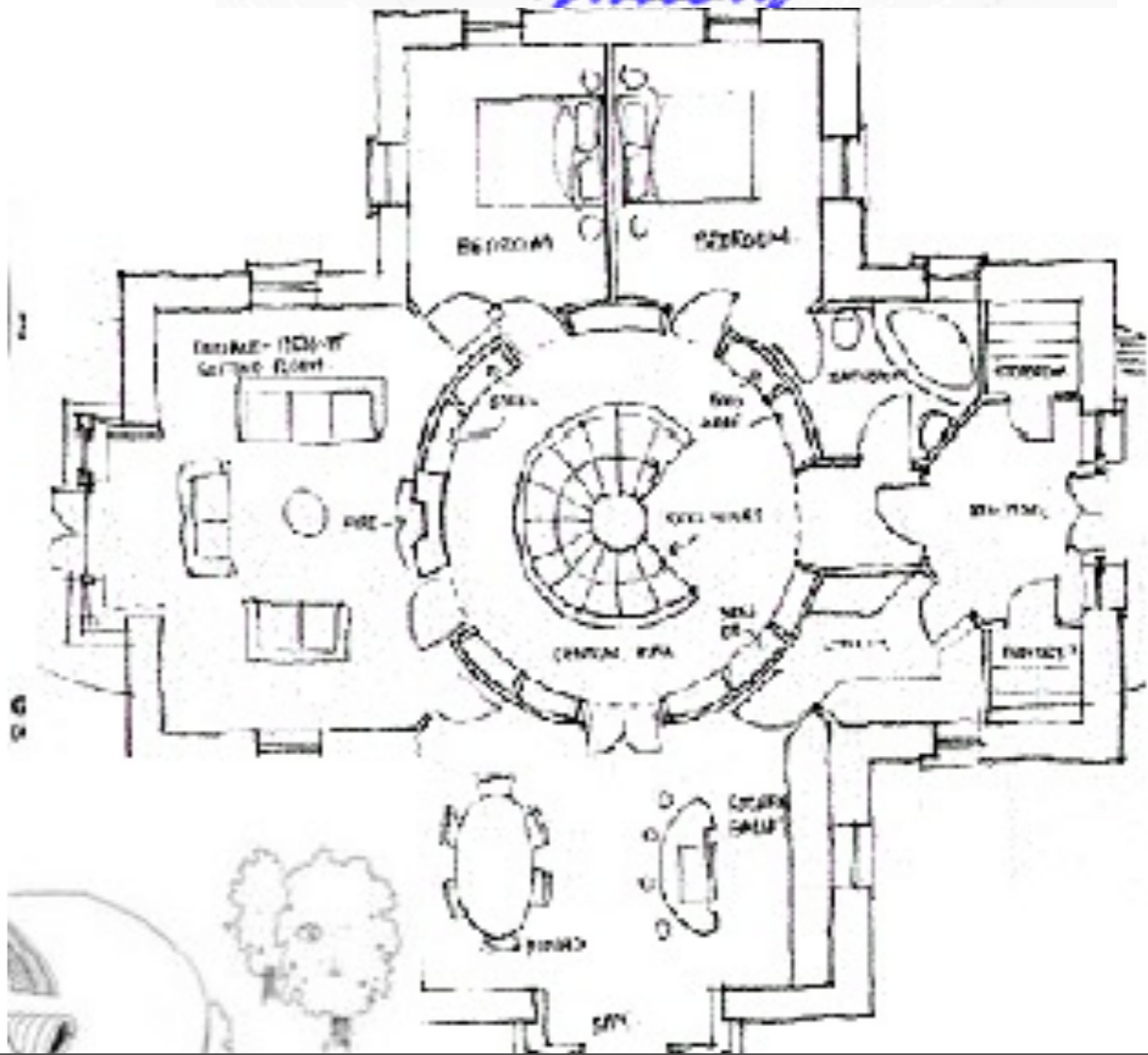

Michael Rice, Dublin.. Dome  
Sacred Architecture

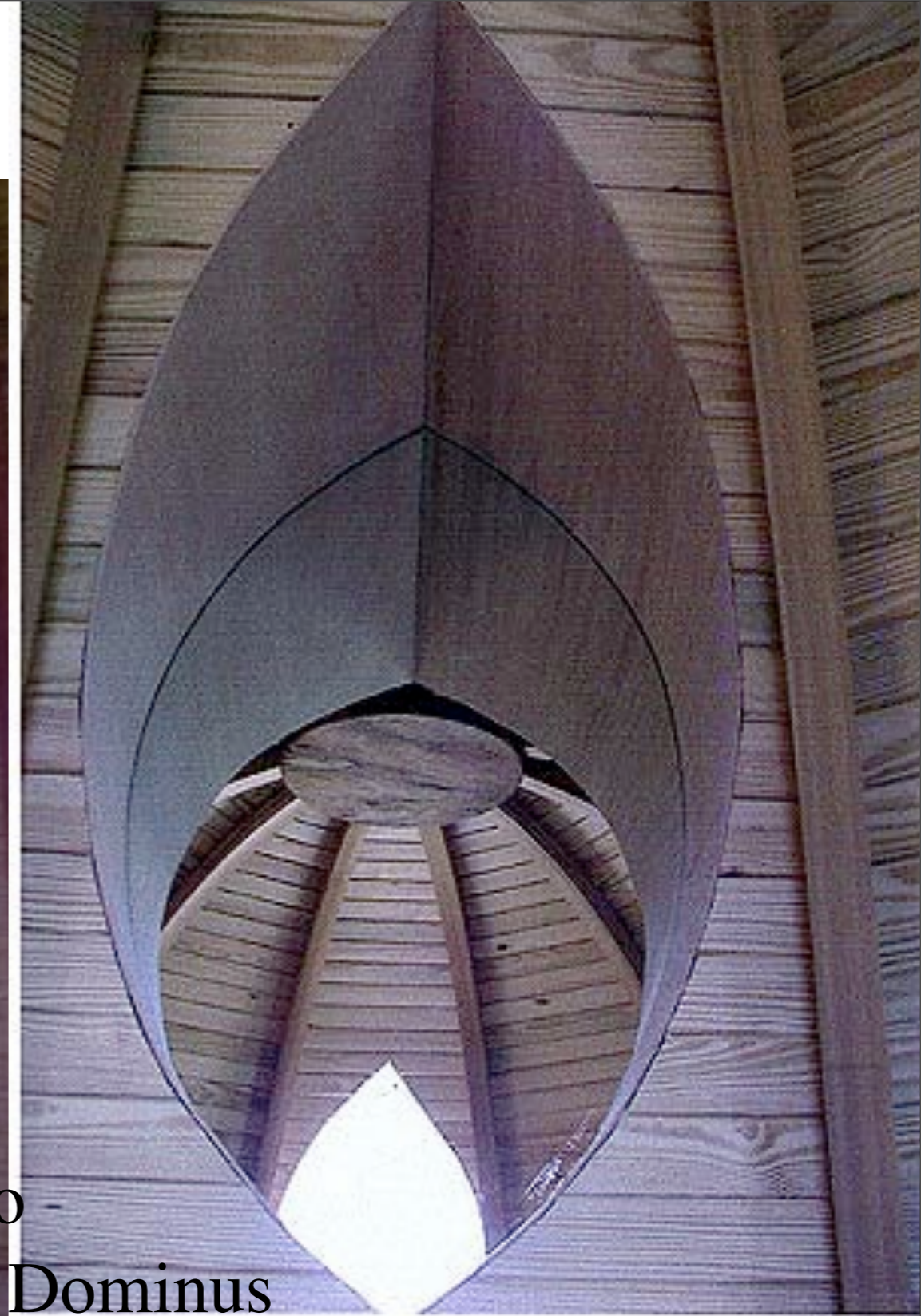

Domo -  
Dominus  
Dominate  
Domain  
Dome..  
EGGs-actly...







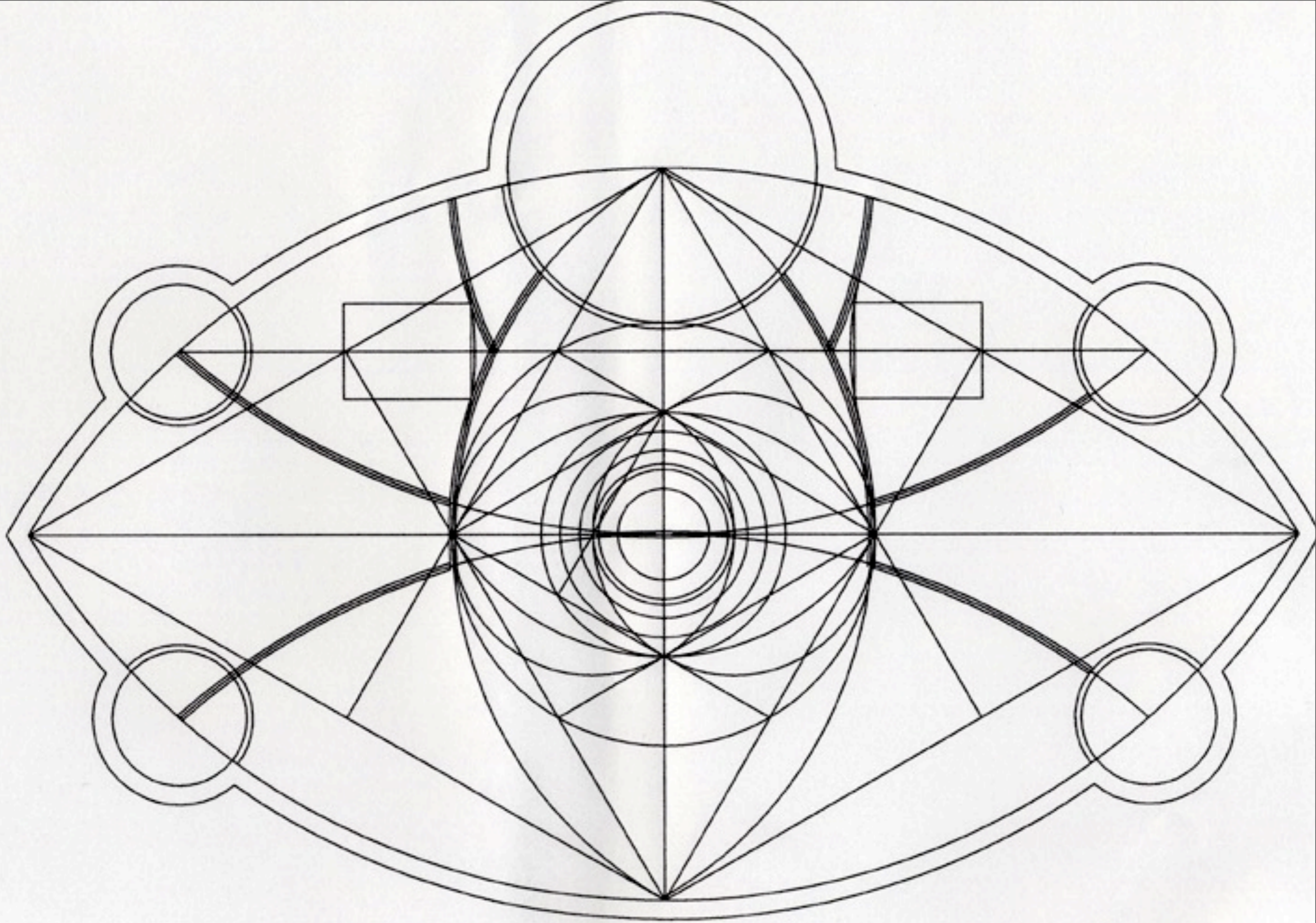

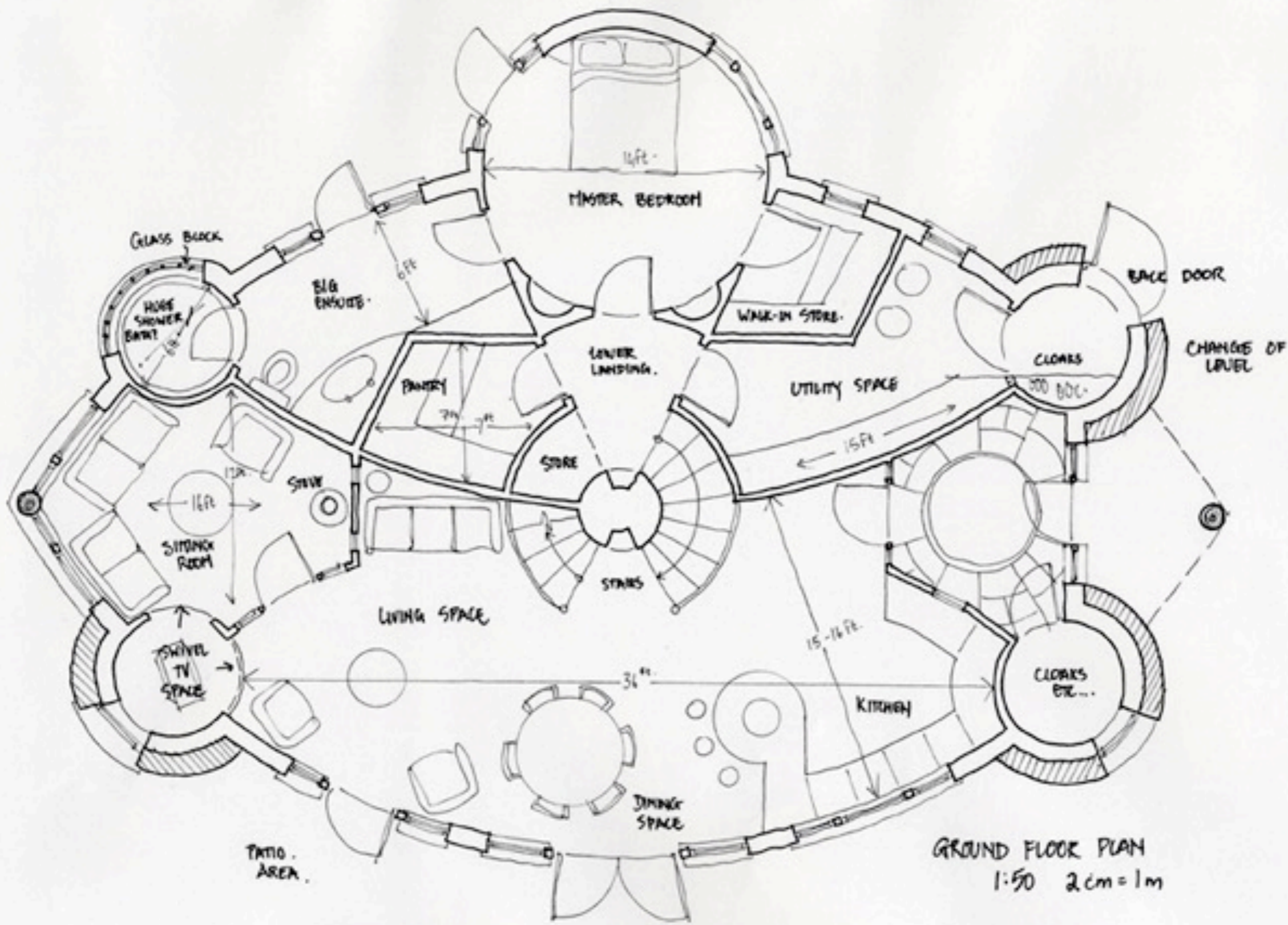





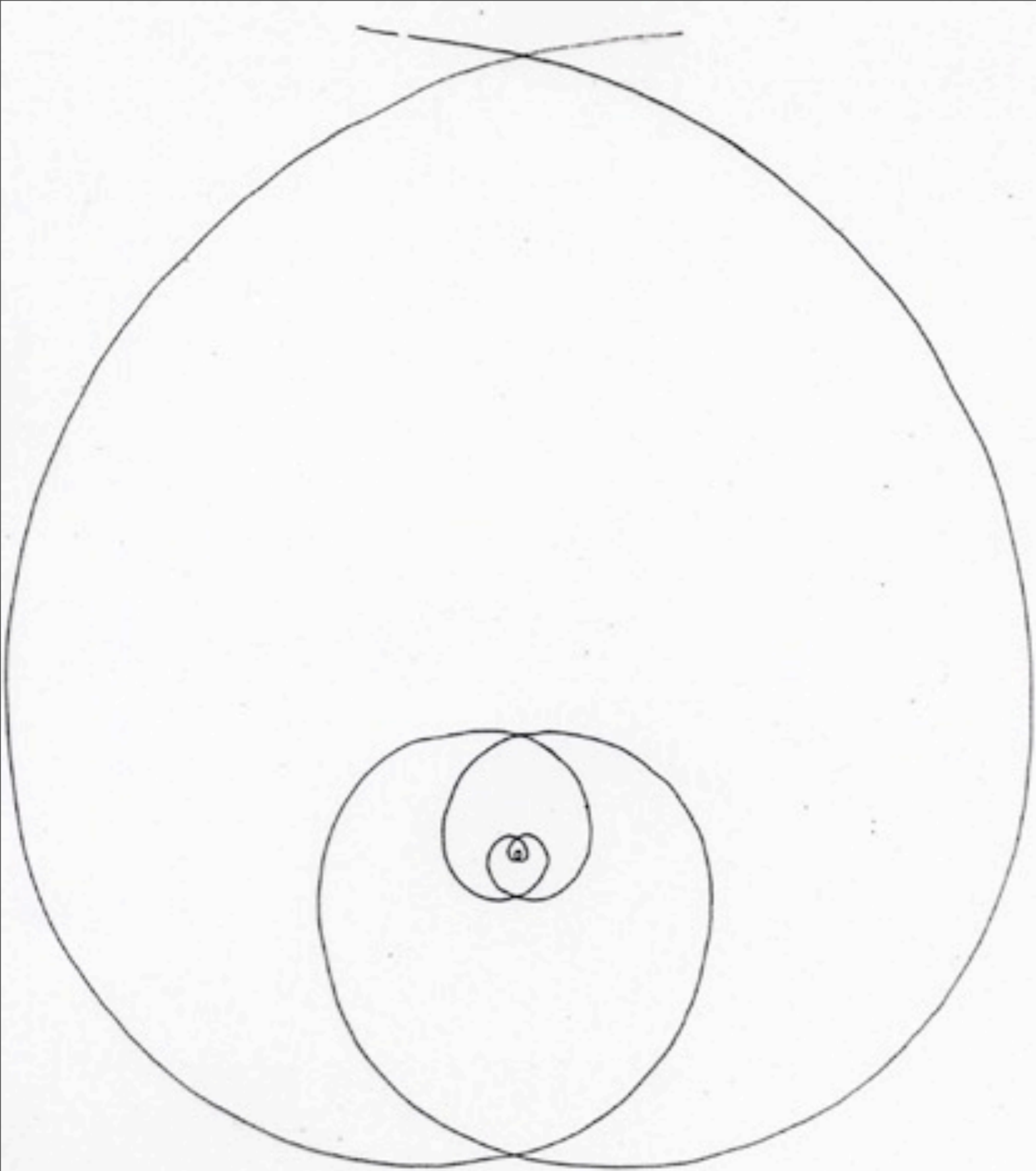

**THE WAVEFORM OF UNCONDITIONAL LOVE  
AS A COHERANT SELF EMBEDDED FORM  
MATRIX FOR THE BUILDING SHAPE**

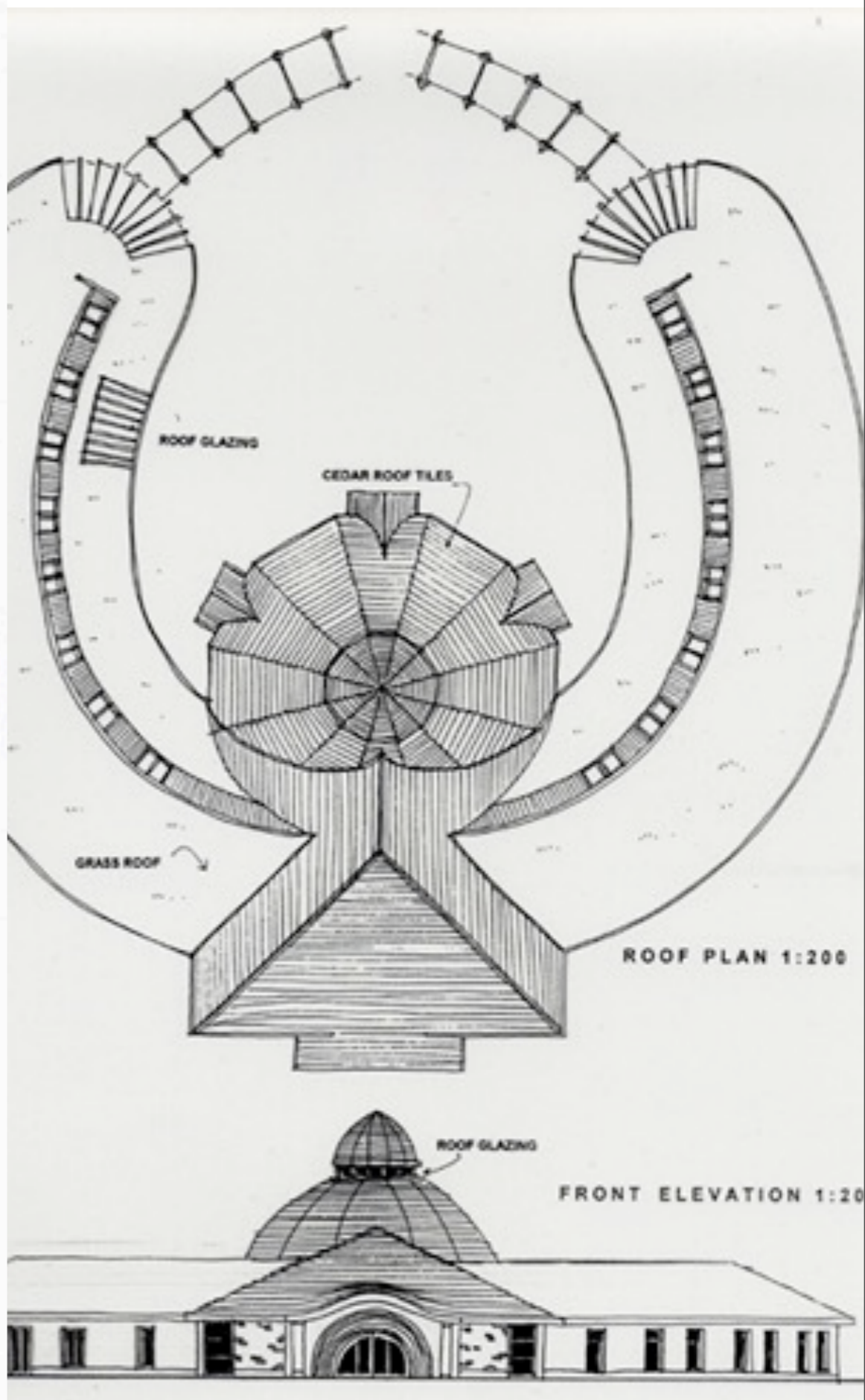

# SLANG SACRED HEALING SPACE



INTERNAL VIEW OF MEDITATION SPACE

The Sacred Space  
or 'Sweet Spot'  
in the room-  
where seeds  
actually  
germinated better-  
is the place  
where  
electric field  
lines  
converge  
**CONSTRUCTIVELY**  
(fractal).

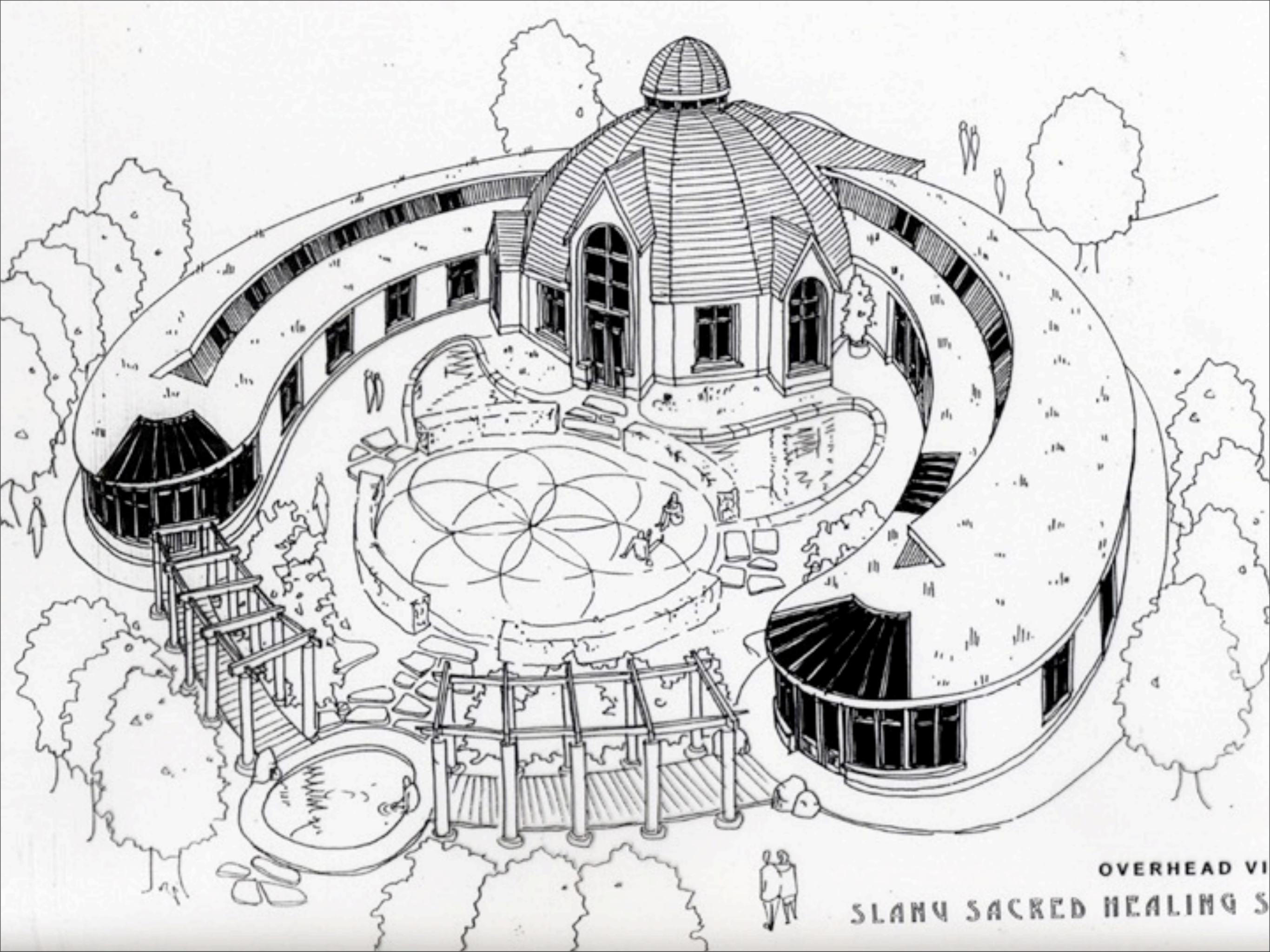

OVERHEAD VIEW  
SLANG SACRED HEALING S



Vesting Bourtange Holland: Re - Penting the Royal history!

# Why the Stupa is a LIVING CAPACITOR:

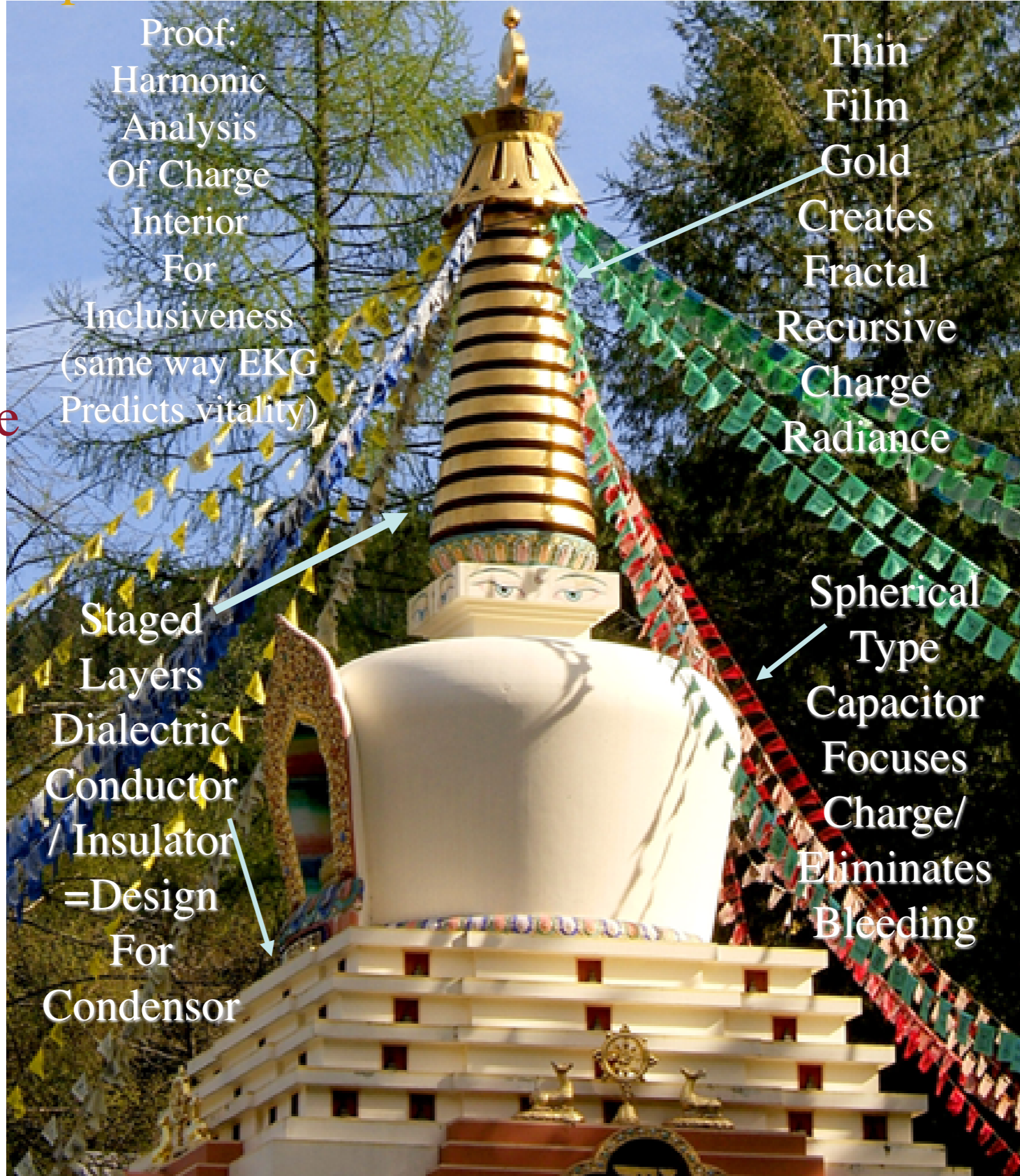

Terms  
Obsolete  
Because  
Imprecision  
Prevents  
Pure Principle  
From Being  
Shared /  
Measured:  
Spirit  
Chi  
Orgone  
Barrakah  
Shakti  
Freshness  
Eck

**Correct  
Description:**  
Recursive  
Capacitor  
Creates  
Successful  
Charge  
Compression  
(Harmonic  
Inclusive  
Electric  
Field)  
-Therefore  
Able  
To Nourish  
DNA,  
A Seed,  
& Bliss/  
Ecstasy/  
Enlightenment

# Living Structure (Sacred Temple): Breathes Charge

*Symmetry  
Of Charge Compression/  
Harmonic Inclusiveness*

## Biologic Architecture: Choice of Material

- The work of biology is to get molecules arranged into a fractal- this accomplishes perfected (non-destructive) distribution of charge - called LIFE. Thus relative fractality (self-similarity) in the charge field allows us to define which building materials can fabricate a structure which causes - life, seed germination, bliss. (Measuring success in Architecture)

<i>Most Fractal (Charge Field Serves ALL Life)</i>	<b><i>Metals</i></b>	<b><i>Woods</i></b>	<b><i>Stone..etc.</i></b>	<b><i>Fabric</i></b>
<p>↑</p> <p>Shape of Charge Radiance (Capacitive Field / 'Spirit')</p>	<p>Gold Palladium Platinum Silver</p>	<p>Close Grained Hi Mineral Content Hardwood</p>	<p><b><i>Granite</i></b> <b><i>Limestone/Calc</i></b> <b><i>Paramagnetic Stone</i></b>  <b><i>Dimagnetic Stone</i></b> <b><i>Sandstone</i></b></p>	<p><b>Hemp</b> <b>Silk</b> <b>Cotton</b> <b>Wool</b></p>
	<p>Copper</p>	<p>Coarse Grained Lo Mineral Content Softwood</p>	<p><b><i>Glass</i></b></p>	<p><b>Polyester</b></p>
<p>↓</p> <p><b><i>Least Fractal (Poisonous to ALL Life)</i></b></p>	<p>Iron</p>	<p>Softwood</p>	<p><b><i>Plastic</i></b></p>	
	<p>Tin</p>	<p>Steel</p>	<p><b><i>Aluminum</i></b></p>	
	<p>Aluminum</p>			

# Here is Life:



Field Effects ARE Your Environment-  
 The FRACTALITY (charge distribution efficiency )  
 of Electrostatic and Magnetic Environment  
 MEASUREABLY determines if Seeds Germinate  
 AND if People HEAL!

# Here is Death: (most buildings today)

*Aluminum and Steel Square Metal Grids (non fractal electric field) are in themselves measureably Poisonous To Every Living Thing*

*- In Todays Nauseating Buildings- this is combined with Extreme ELECTROSTATIC and ELECTROMAGNETIC (and audio hum) POLLUTION*

*- The COMBINATION is TRULY SICKENING*

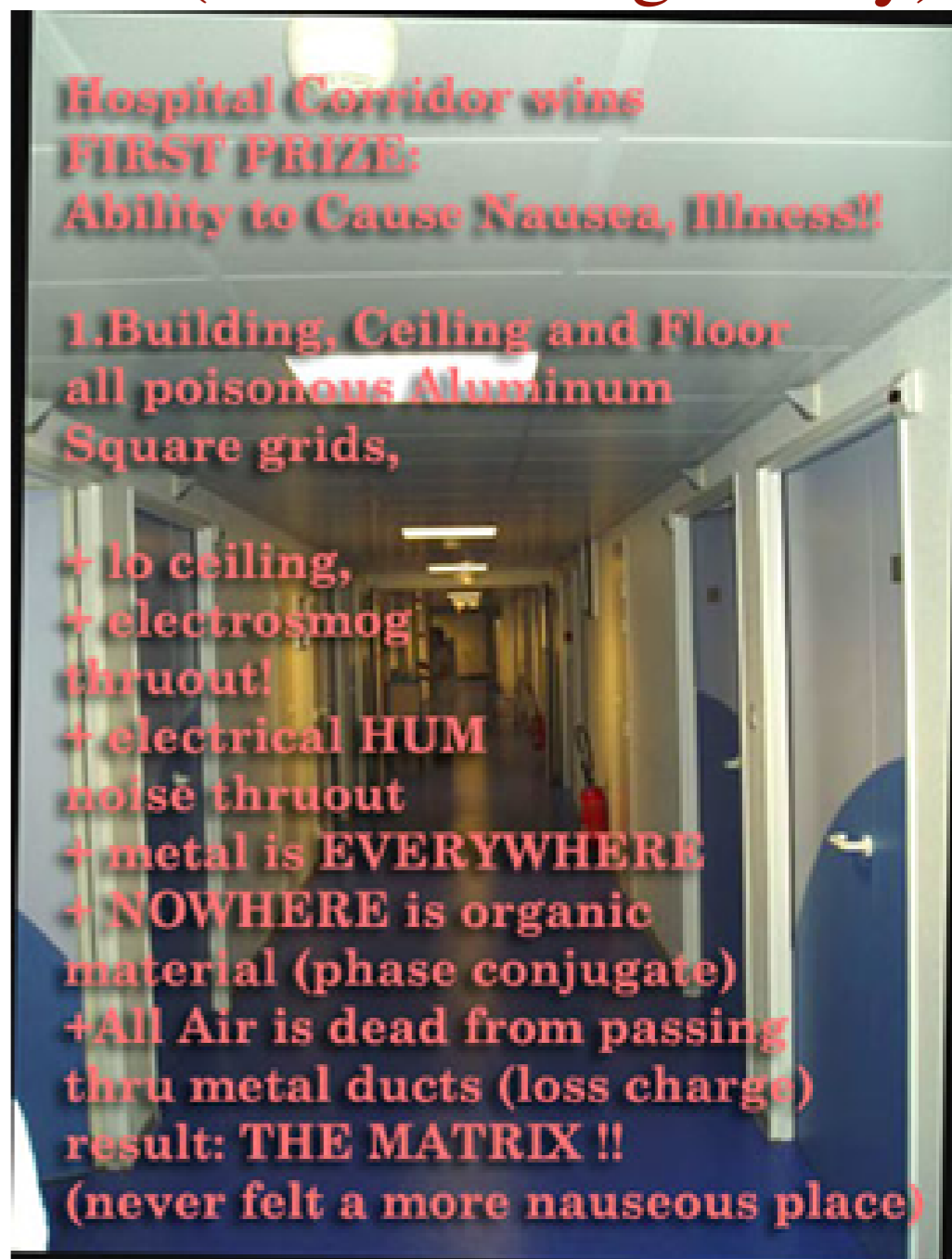

# Ron Eglash - explains his beautiful work on FRACTALITY- in ancient / sacred African Architecture

Since we have a similar structure at all scales, this architecture is easy to model with fractals. Figure 1b shows the first three iterations. We begin with a seed shape that could be the

Dr. Eglash explains **FRACTALITY** in Village Design in African Ba-ila..

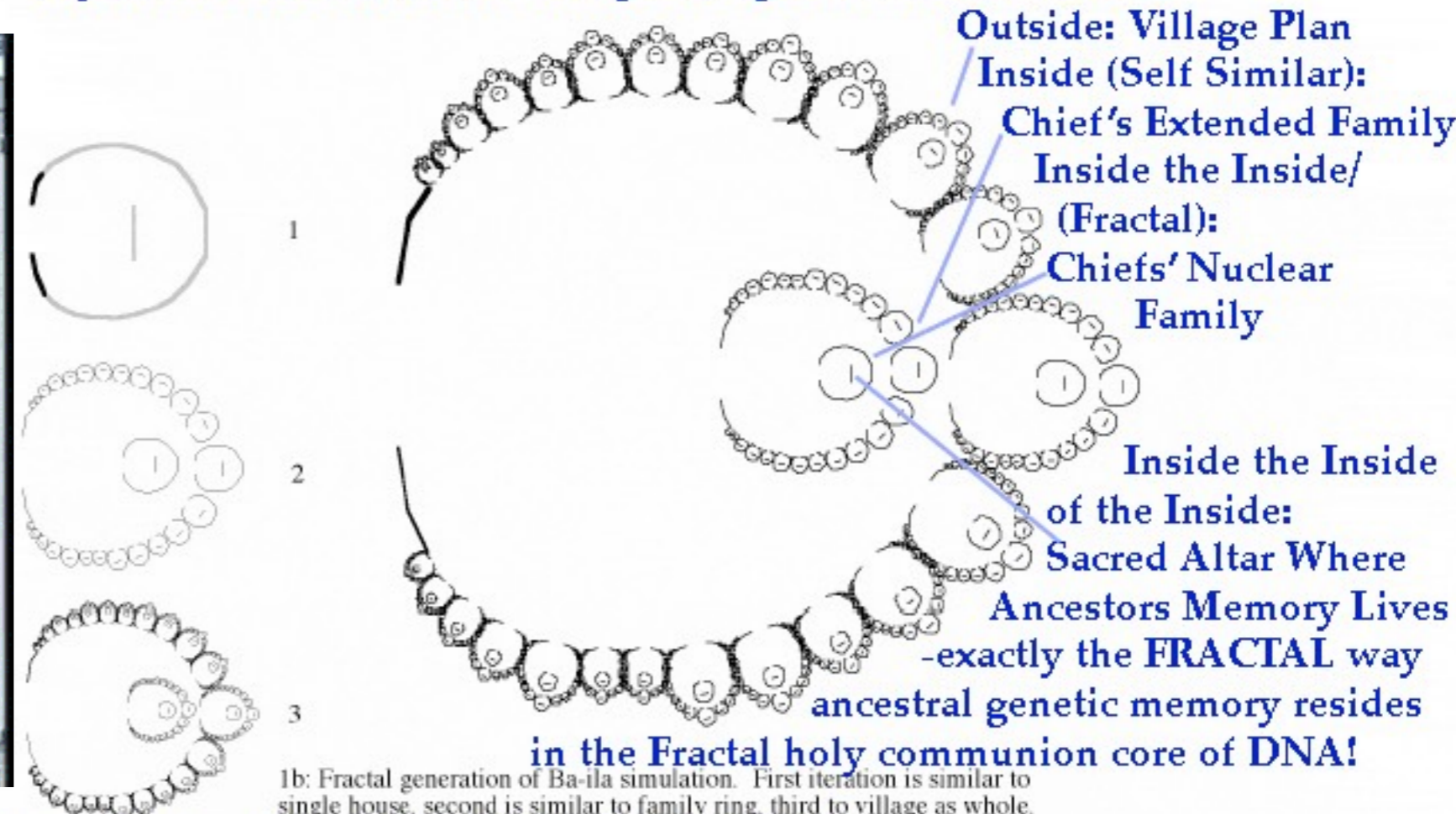
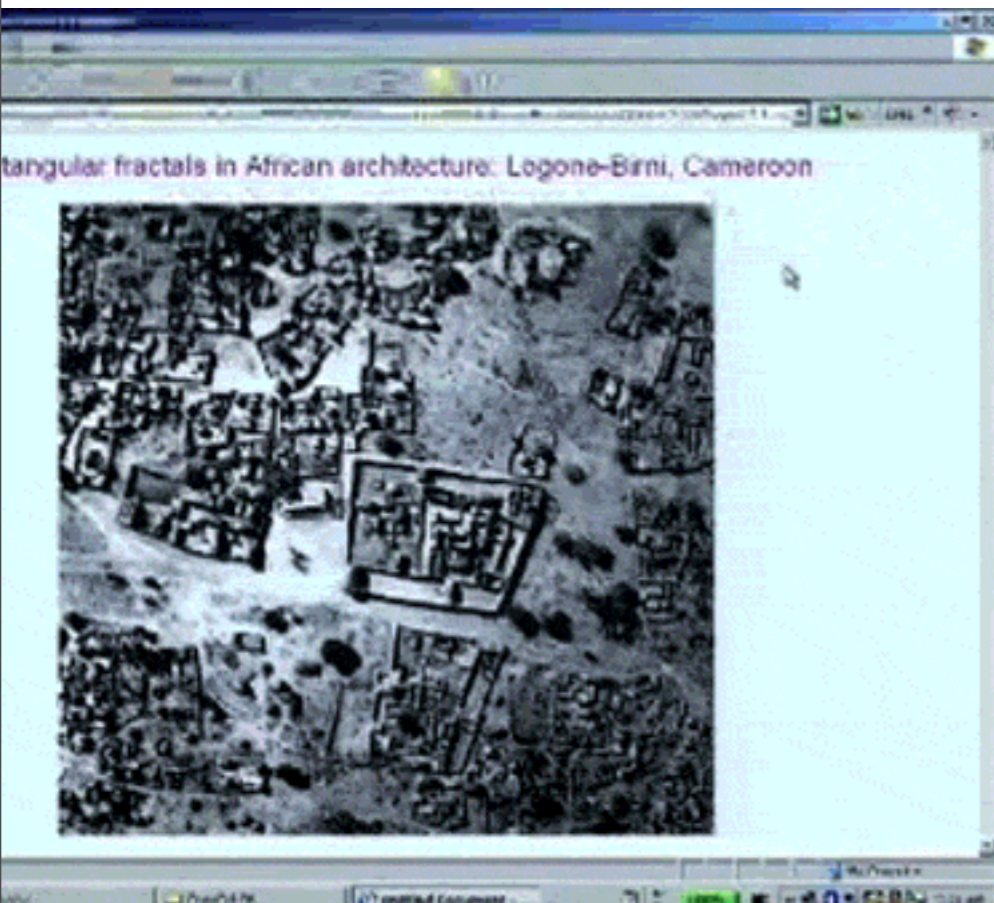

From *Fractals, Complexity and Connectivity in Africa* by Eglash & Odumosu - <http://www.rpi.edu/~eglash/eglash.dir/afactal/develop.htm>

Figure 1b. Fractal pattern in Ba-ila settlement. overhead view of a single house. In the next iteration, we have a shape that could be the overhead view of a family enclosure. Finally, the third iteration provides a structure that could be the overhead view of the whole settlement. Note that the self-replicating line off-center is the position of the altar in the house, and the position of the village altar in the chief's family ring: a resonance between spiritual notions of endless renewal, mathematical models of self-replication, and physical structure that we see in many of the fractal village architectures of Africa.



	A	B	C	D	E	F	G	H	I	J	K
1		Area	Areanorm.	AverageIntens	Numberoffrag	Formcoef.	Entropyisol.	Fractalityisol.	Fractalityerror	MeanRisoline	NRMSofisoline
2	...0001.bmp	17194	0	91.81	1	2.61	1.88	1.92	0.07	65.56	0.03
3	...0002.bmp	17887	948.93	93.64	1	3.04	1.45	1.87	0.09	61.21	0.08
4	...0003.bmp	19008	403.36	99.21	1	3.04	1.85	1.86	0.12	60.35	0.09
5	...0004.bmp	18578	657.06	98.69	1	3.06	1.78	1.86	0.12	61.25	0.08
6	...0005.bmp	19920	1056.79	102.02	1	3.04	1.13	1.74	0.07	62.96	0.09
7	...0006.bmp	19781	0	100.82	1	2.61	1.86	1.88	0.07	67.72	0.04
8	...0007.bmp	19937	0	99.29	1	2.74	1.89	1.85	0.07	67.78	0.04
9	...0008.bmp	20321	404.27	103.21	1	2.85	1.96	1.8	0.07	64.58	0.05
10	...0009.bmp	19679	189.82	103.13	1	3.48	1.54	1.71	0.07	59.86	0.13
11	...0010.bmp	20018	0	101.1	1	2.67	1.98	1.87	0.06	68.15	0.04
12											
13	Mean	19232.3	366.02	99.29	1	2.91	1.73	1.84	0.08	63.94	0.07
14	RMS	1039	404.14	3.82	0	0.27	0.27	0.07	0.02	3.25	0.03

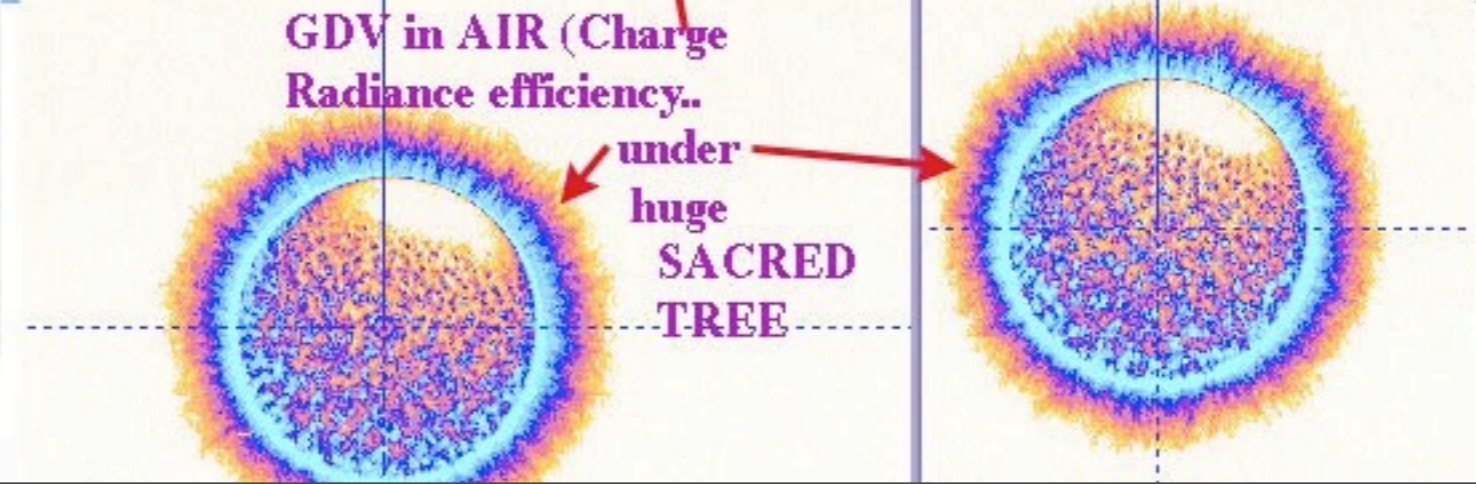
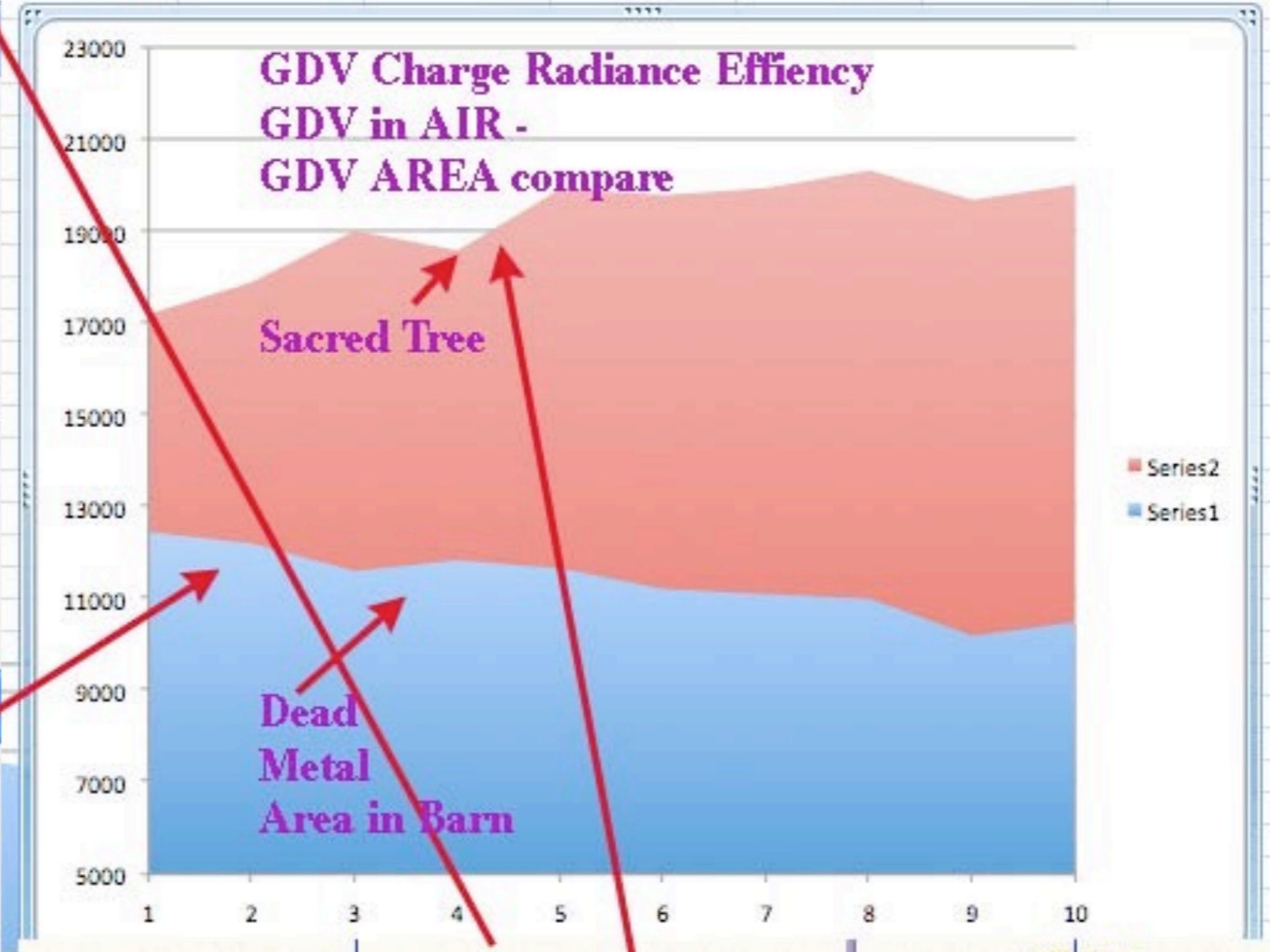
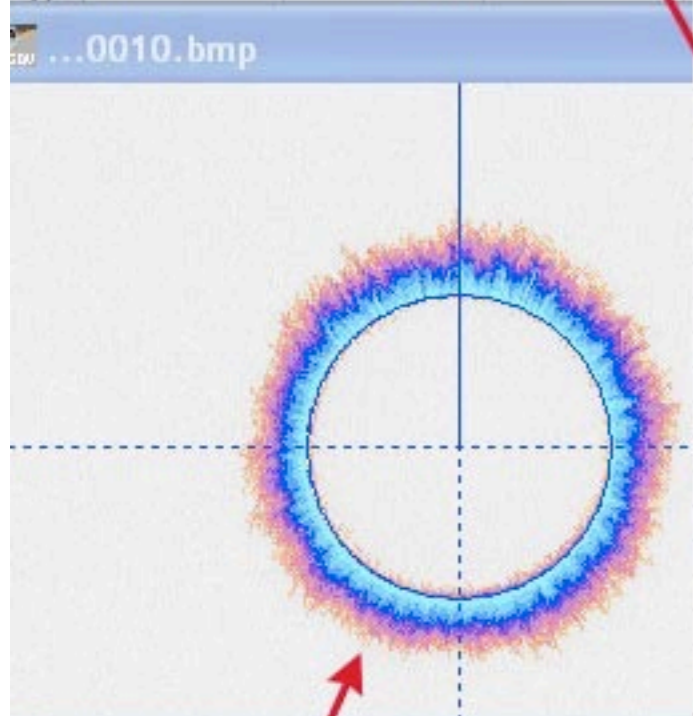

	A	B
1		Area
2	...0001.bmp	12450

A large group of approximately 250 people, including men, women, and children, are posed on the wide stone steps of a large, multi-story brick building. The building features a prominent 'U' logo on a blue square sign. The group is arranged in many rows, filling the steps from the foreground to the background. The scene is brightly lit, suggesting a sunny day. The text overlay is positioned in the upper right quadrant of the image.

*250+ Architects, Professionals, Government and University  
Representatives from over 12 countries gathered for  
our BIOLOGIC ARCHITECTURE Conference  
IberoAmericana University  
Mexico Oct 12-14, 07*

**Saturday 3rd October 2009**

10am - 6pm at Chapter, Cardiff

**Sunday 4th October 2009**

10am - 6pm at Coed Hills, Cardiff



**presents.....**

# LIFE FORM

**conference exploring biologic architecture, holistic building systems and geomantic built environments**

**SPEAKERS INCLUDE:**

**Michael Rice**  
Biologic achitecture in commercial practice and beautiful detailing for harmonious environments

**Oldrich Hozman**  
Holistic construction processes and criteria for success in biologic architecture and sacred space

**Shaun Kirwan**  
Good practice for geomancy in architecture and designing in accordance with earth energies

**Dan Winter**  
Science of buildings with life supporting electric fields and designing spaces as living capacitors.

**Arturo Ponce**  
The energetics of cities and build up of electrosmog

**workshops in constructing energetically harmonious landscapes and life-supporting architecture**

**ACTIVITIES INCLUDE:**

**Site Visit**  
Meet up at ancient burial chambers in Tinkinswood

**Making a Labyrinth**  
Construction of an active labyrinth in the forest

**Sculpture Installation**  
Unveiling competition winning design run by BioArchitecture Foundation (see website for brief)

**Giant Mandalas**  
Workshop with Tim Halewood and talk on colour theory

**Guided Tour**  
Architecture, sculpture and sacred spaces integrated into community

networking ● discsions ● bookstall ● refreshments ● exhibition

poetry ● artwork ● storytelling ● bonfire ● barbecue



**Tickets £15 per day. For more information and online booking go to [www.biologicalarchitecture.co.uk](http://www.biologicalarchitecture.co.uk) or call 07973 282 725**

- Our 2009 International Conference on
- Biologic Architecture
- Oct- in Cardiff, Wales

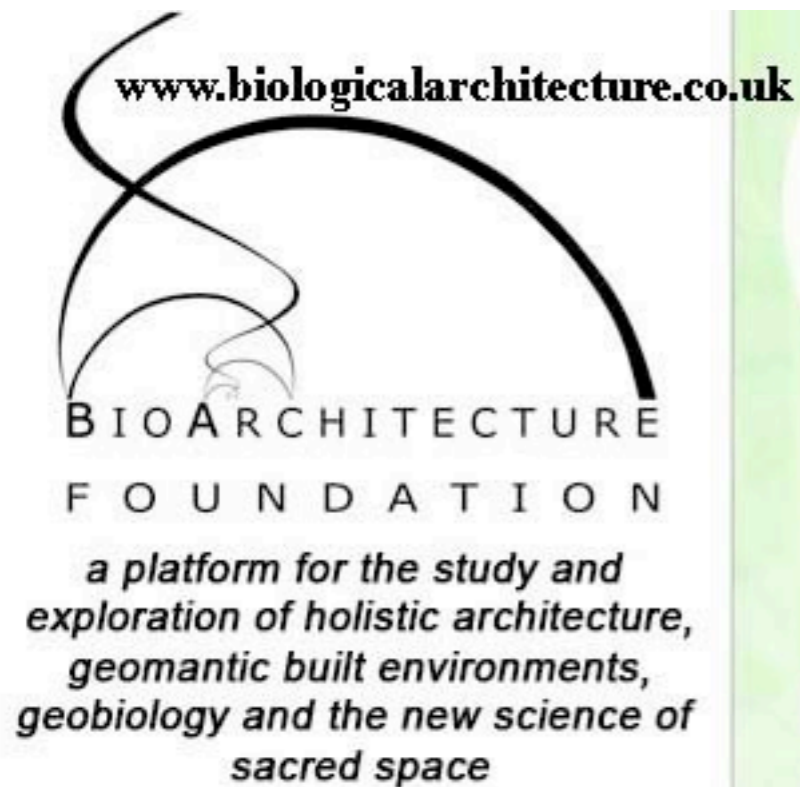

BioArchitecture harnesses and replicates the principles found in nature in order to create built environments which affect people and other living things. Although many people are aware of the aesthetic beauty of buildings which are influenced by natural forms and built with natural materials, the full effect of designing in accordance with nature is not widely understood. The central canon of BioArchitecture is that all life responds well to design that is energetically harmonious with nature.

In studying the environment necessary to support life, it may be possible to redefine the function of architecture as a discipline which enables people to build spaces which have a physically positive effect on living things. There is evidence of this craft being rediscovered time and again throughout recorded history, and awareness of the deeply fascinating connections between the animate and the inanimate is once again demanding our attention.

The BioArchitecture Foundation was created to allow the quick dissemination of information in this field as it unravels. We encourage you to not only study the information we offer, but also to participate in the forum, competitions, and to contact us with material from your own research which we may post on this site. Please come back to check this site for new reports, news and upcoming events.

**Compare to**

**Professor Phil Callahan**

## **Magnetic Flux Permissivity Meter**

**(available thru Acres Magazine )**

**Predicting Soil Fertility**

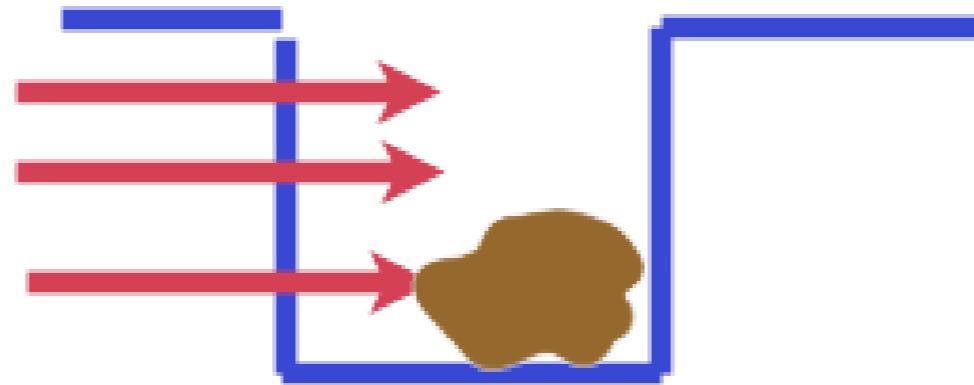

Measuring the

Resistance

To the Passage

Of Magnetic Flux

(‘Permissivity’)

Through the Soil

(A Function of

Symmetry in the Soil)

Can Predict not only

- Fertility

- Presence of ‘Ley’ or

-

**Prof. Phil Callahan predicted by measurement where war breaks out (Isreal, Yugoslavia, Ireland etc)  
By measuring where soil magnetic lines break down (create resistance)**

**If Symmetry Permits Magnetic Lines from Village A to touch Village B  
Then - their emotional communing of touch - prevents WAR from Breaking out..  
Restore Symmetry (Labyrinth / Stone Circle - Eliminate Metal)  
And PEACE BREAKS OUT!**

**Peace University: [soulinvitation.com/peaceuniversity](http://soulinvitation.com/peaceuniversity)**

**We measure ability to embed & receive life force with Electric Charge Permittivity**

- **Peacemaking in the MIND**, a teachable frequency signature in the EEG based on phi and implosion
- Electrical geometry of bliis, euphoria, transcendence
- The CENTERING and peacemaking force of attention itself as implosion in brainwaves -
- coherence in it's sustainable measure IS recursive embedding.
- **Peacemaking the the HEART** (COHERENT EMOTION), Coherence and Centering Force in the EKG.
- - Peacemaking in the LAND
- - **Peacemaking in the shape of human TOUCH**
- - **Peacemaking in the shape of Sacred DANCE and Movement**
- **Peacemaking in MUSIC - Music of Bliss and music of the EKG** - Intro to spiritual 'RAVE'- Bliss and Peace without Drugs
- - Peacemaking in the breath ( pic below)
- **Peacemaking by restoring MEASUREABLE CHARGE -a**
- **teachable and testable definition of life-force to food, and architecture and land**

-

# Proposal for Commercially Successful Next Steps to Implement Re-Vitalizing Australia Water

1. Modest Support to Complete Prototype of Next Phase of Implosion Vortex Water Energizer. (Steve Tribbeck)
2. Implement new measurement scientific documentation of life-force. Includes - a) seed germination tests, b) charge density -see capacitance power spectra , c) specific gravity , d) laminar coherence measured by light scattering - ref.Patterson, e) sedimentation rates to segregate solids by mass/specific gravity .. Etc.
3. Proof by measurement of precipitation generation that long wave magnetic lines arranged in rose/ fractal/ labyrinthine array ATTRACT RAIN (by Implosion) ref. Witherspoon. Also prove by measurement that genetic diversity attracts rain. (similarly that monoculture repels rainfall.)

Because:

Water-follows magnetism-follows symmetry - follows Implosion. (Example - compost pile temperature increases by steering magnetic lines into it.)

# Life Force Cycle Map

(harmonic inclusiveness of charge density)

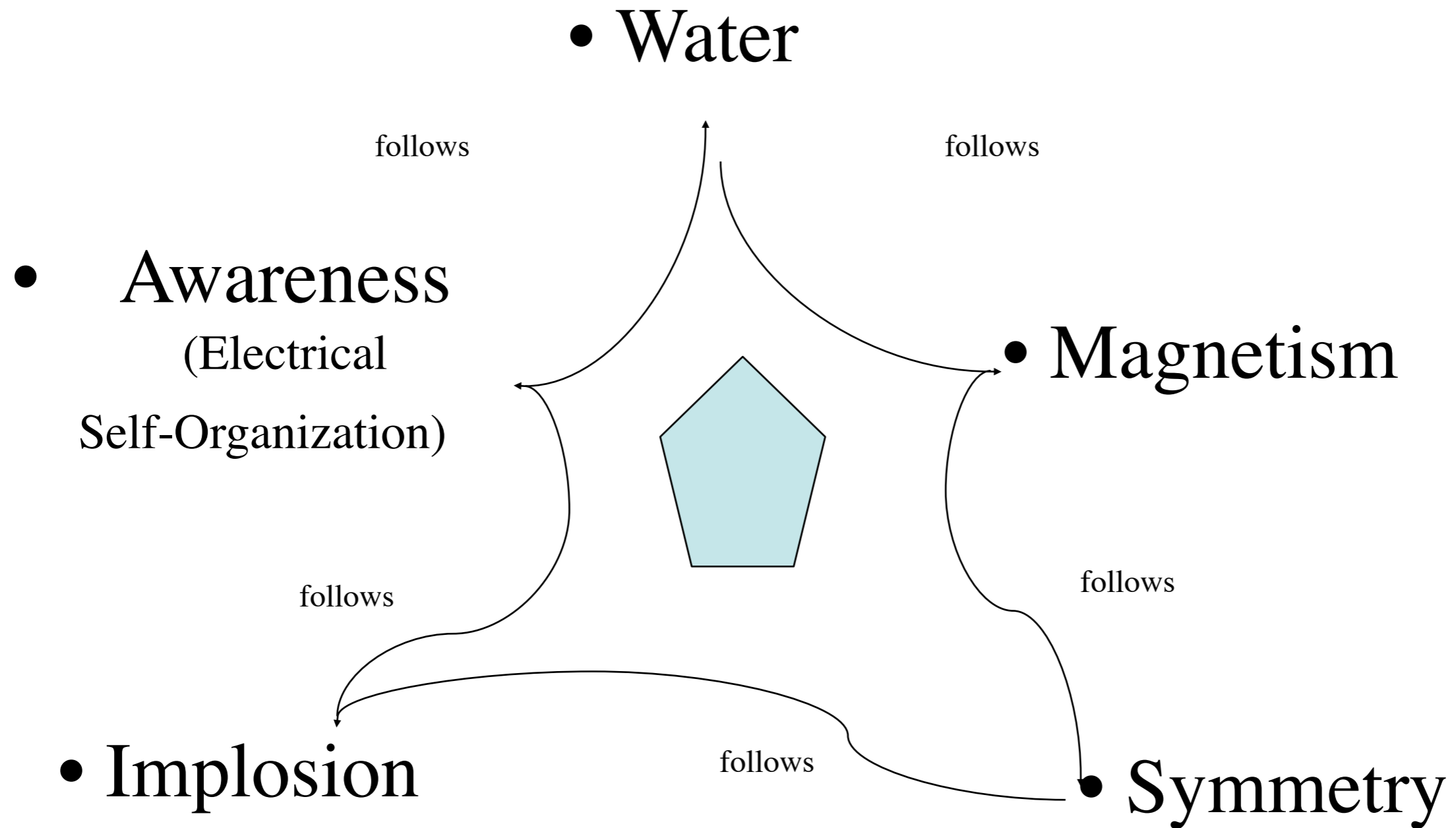



# DESERTIFICATION, Patriarchy and "Hard-Making Power".

also: How to Make Rain- Science of Charge Compression.. [soulinvitation.com/rain](http://soulinvitation.com/rain)  
Why metal fences and roofs and farms PREVENT it from raining!

"Origins of Armoring in Saharasia, c.4000 BCE. (Copyright 1996)

From Dr. DeMeo's book on the subject. DeMeo's Saharasia discovery was the result of the first-ever global geographical mapping of data on human behavior, from ethnographical sources as found in university libraries the world over."

ref- James DeMeo PhD: <http://www.orgonelab.org>

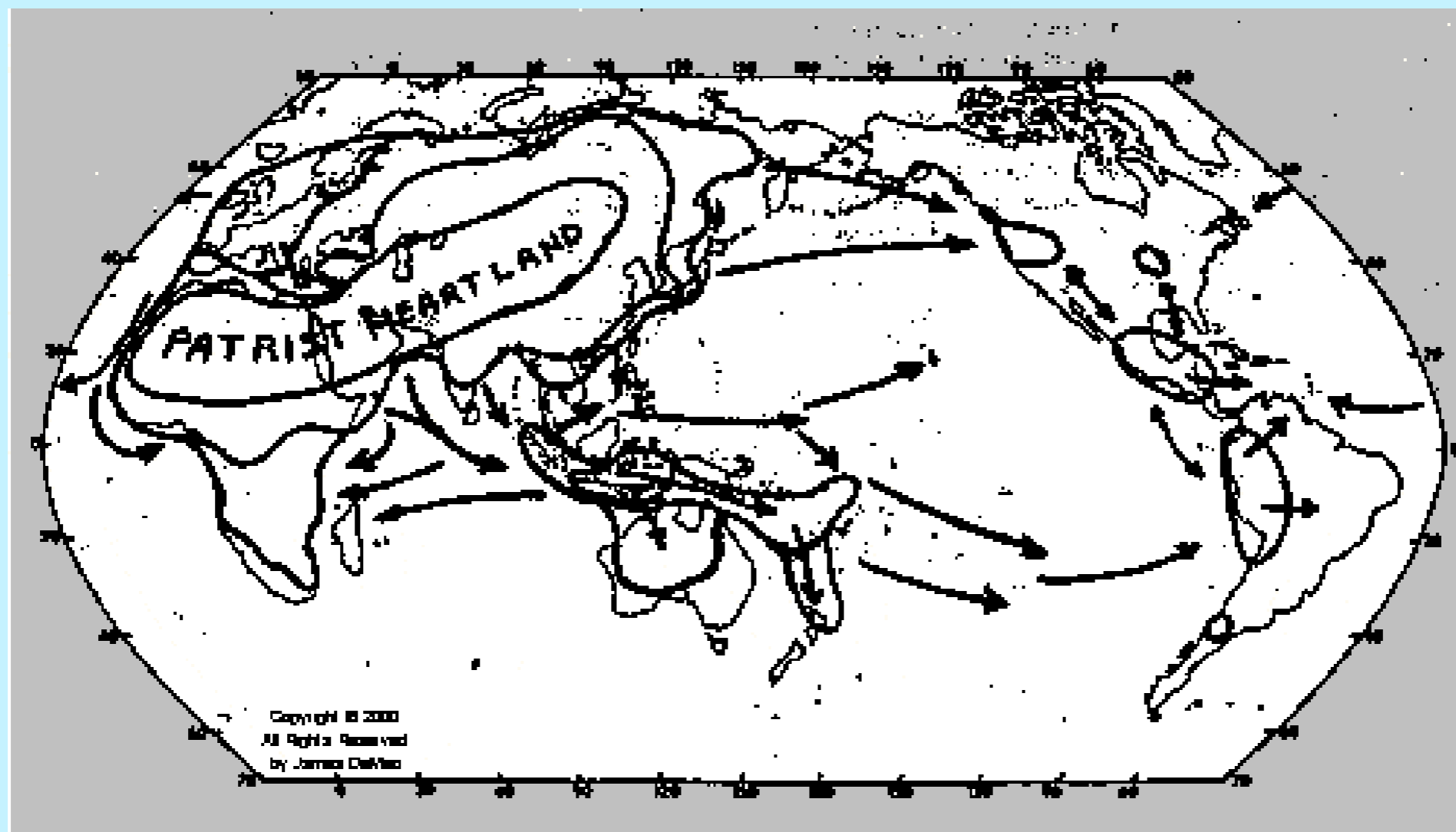

from Dan: Map the spread of laws preventing public affection,  
and you map the spread of the giant desert.

reason is - this prevents short waves from (touch!) columnating (precipitating) into long

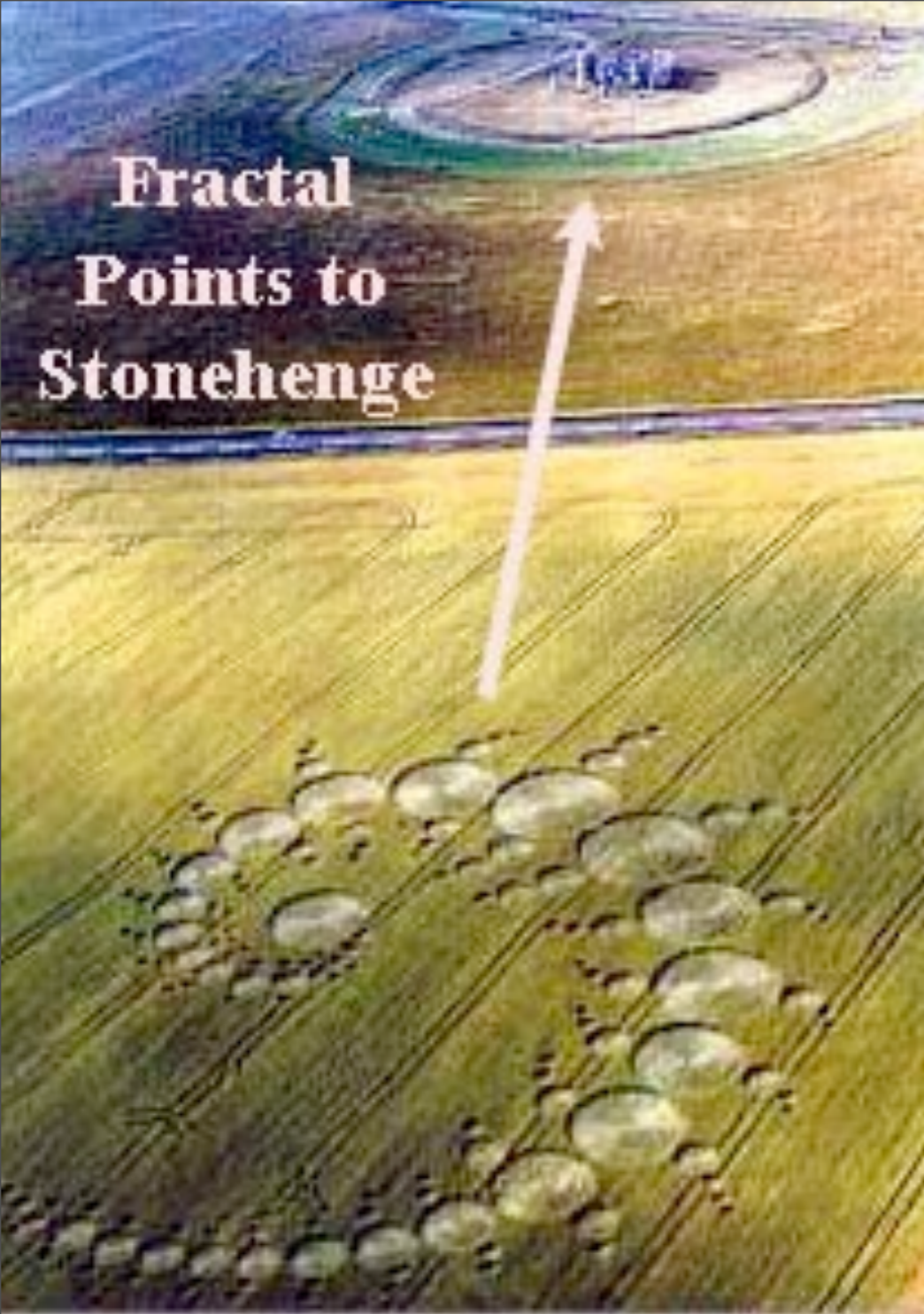

[www.pbs.org/wnet/secrets/case\\_stonehenge/](http://www.pbs.org/wnet/secrets/case_stonehenge/)

Why nature works so hard to get fractal?  
Heart Wires, Lung Branching, Phylotaxis...

Because  
Non-Destructive  
Charge  
Compression  
Creates  
Life  
ITSELF!  
(& Gravity & DNA)

Architecture  
&  
Agriculture  
Take a Lesson!!

Image Credit:  
Romain



## REAL Physics of Feng Shui:

Experimentally- It is self-evident that fractal (constructive charge compressing)  
magnetic environments (opposite of metal buildings and electrosmog)

best feed and support all DNA (every living thing)..

So why is this not taught at any agriculture or architecture school..

Or government? Could it be they are this stupid?

Willing to let you die... fractionated?

*Robert Lawlor /Schwalor de Lubitz*  
*Temple in Man - and Stonehenge*  
*Are examples of Biological Capacitance*  
*Arranged into Fractality to Concentrate*  
*LIFE FORCE- / germination.*

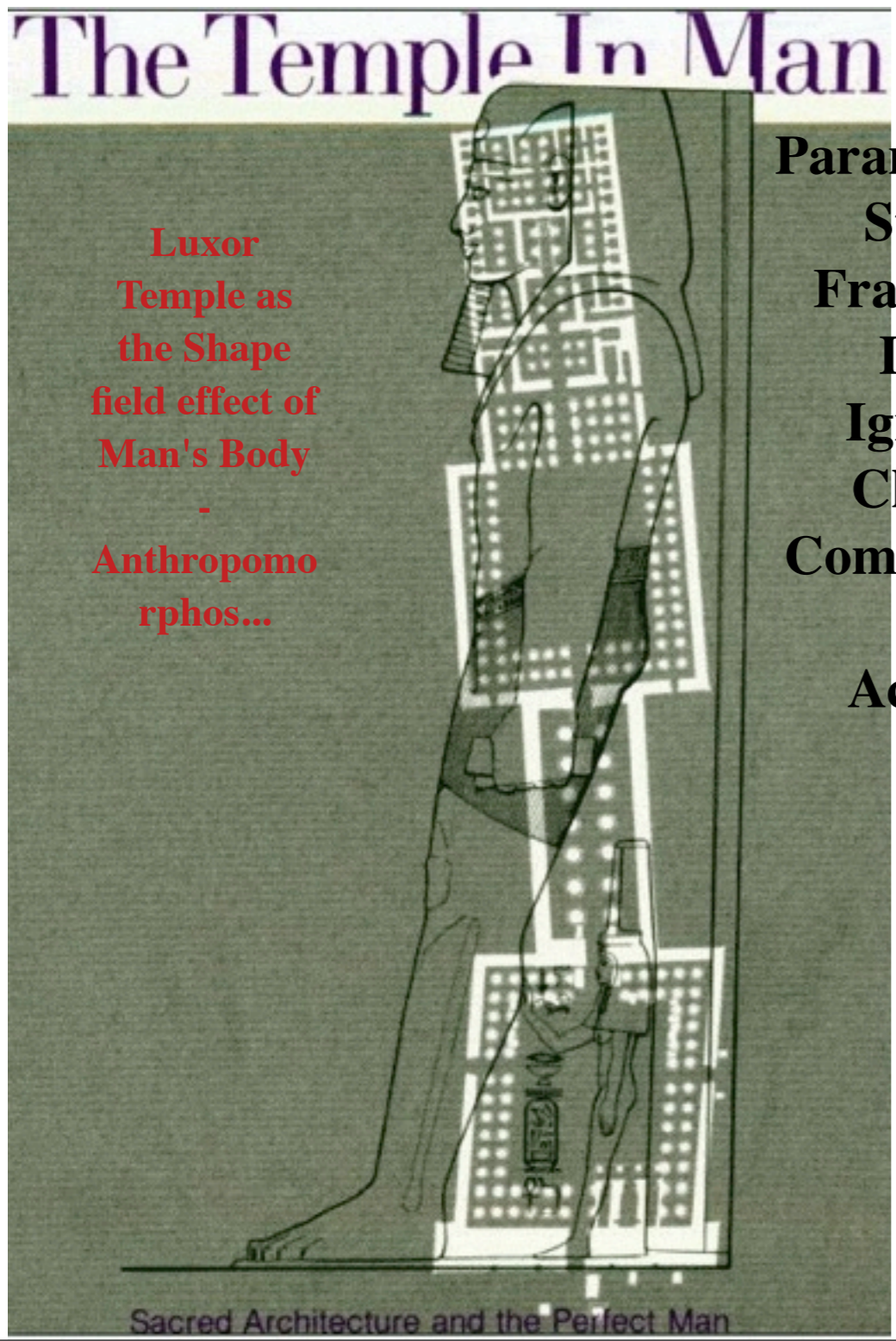
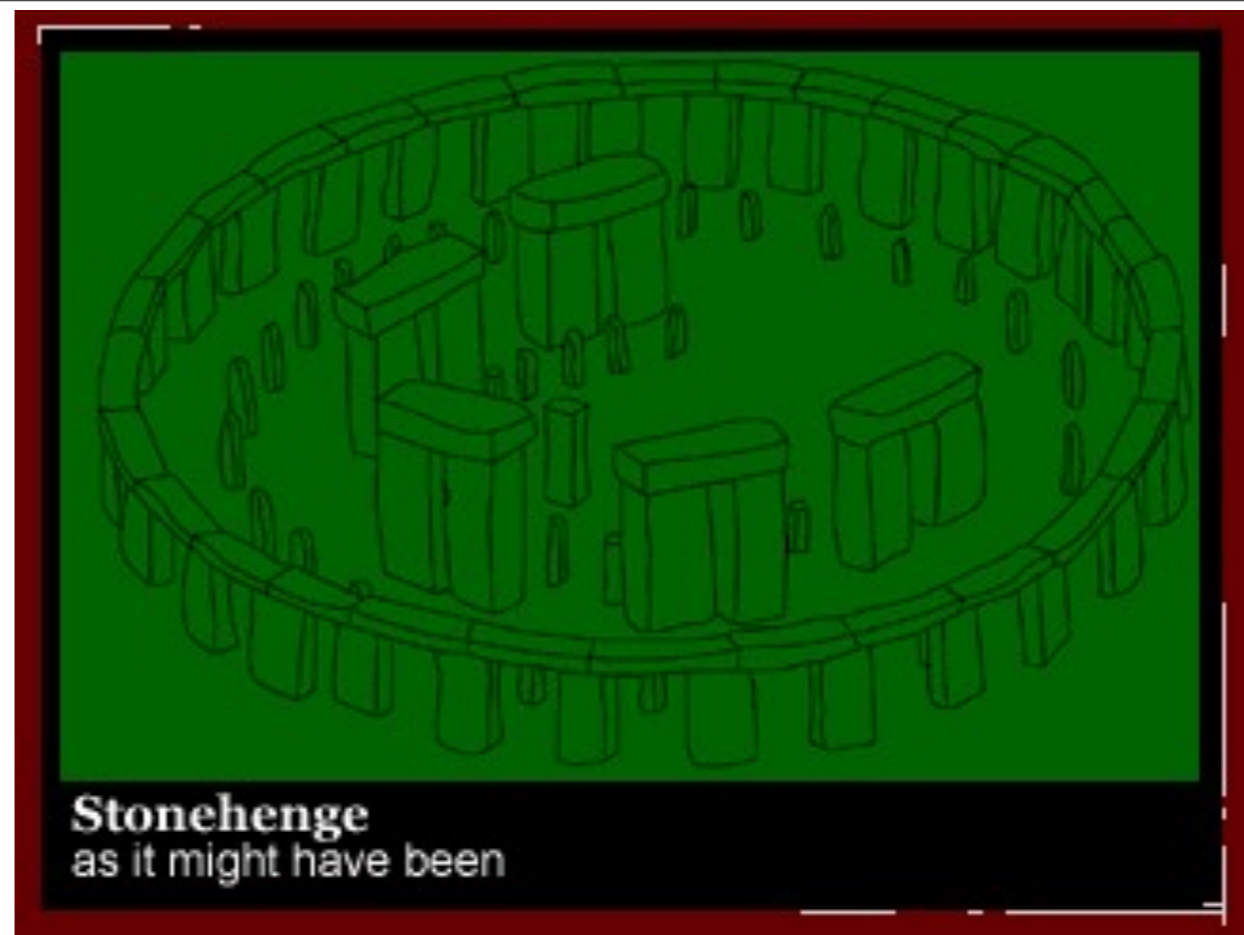

**Paramagnetic  
 Stone:  
 Fractality-  
 DNA  
 Igniting  
 Charge  
 Compression  
 In  
 Action..**

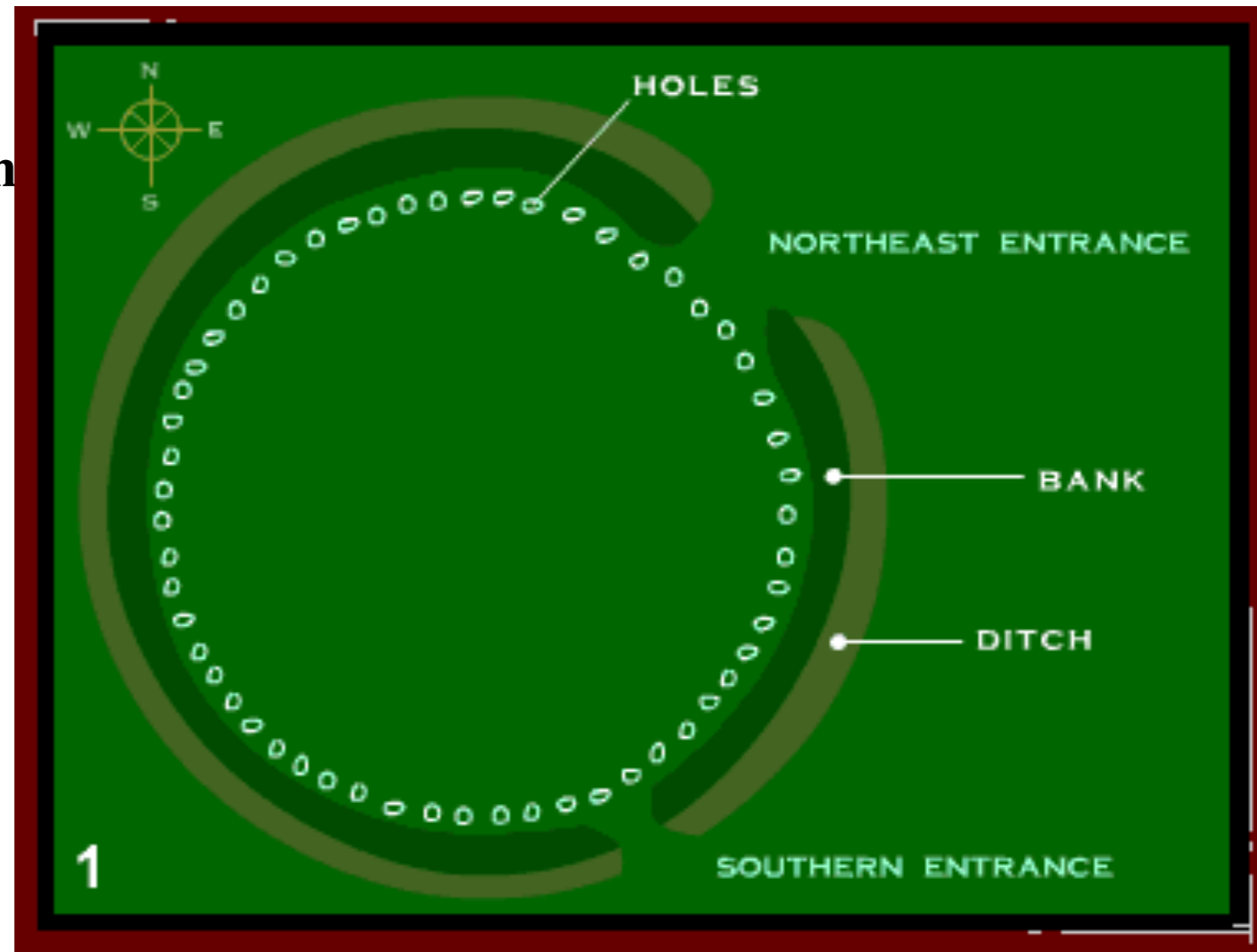

# Trees as Field Indicators for SHAPE of the Charge Field



Tree limbs can bend into  
the fracture path 

*Plants Follow the  
SHAPE of the  
Ambient Field Effect  
Of CHARGE..*

# THE TEMPLAR MERIDIANS

THE  
SECRET  
MAPPING  
OF THE  
NEW WORLD

Arcadia: Grail Settlements  
AND the GOLD  
At FRACTAL Ley Crosses

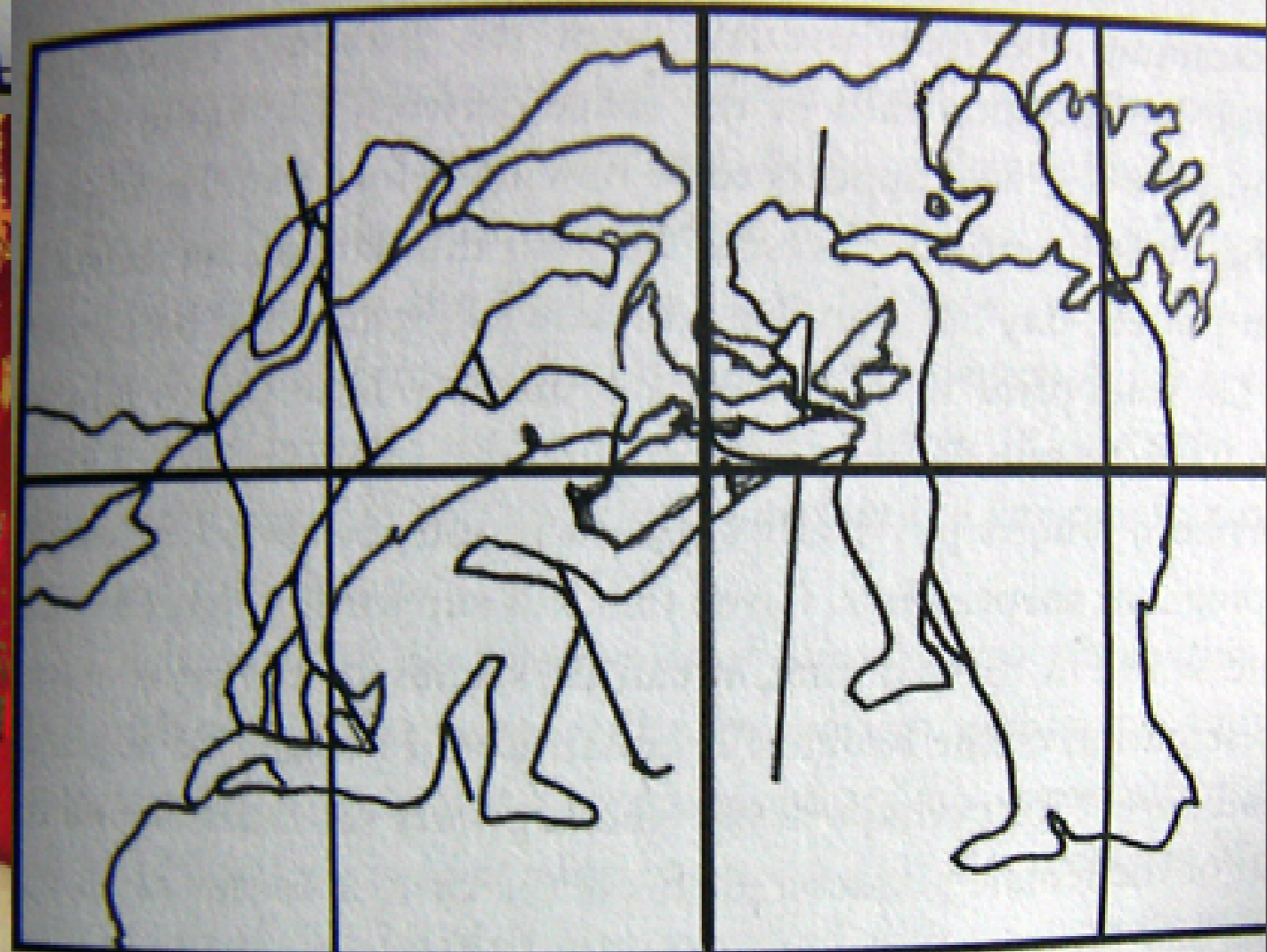
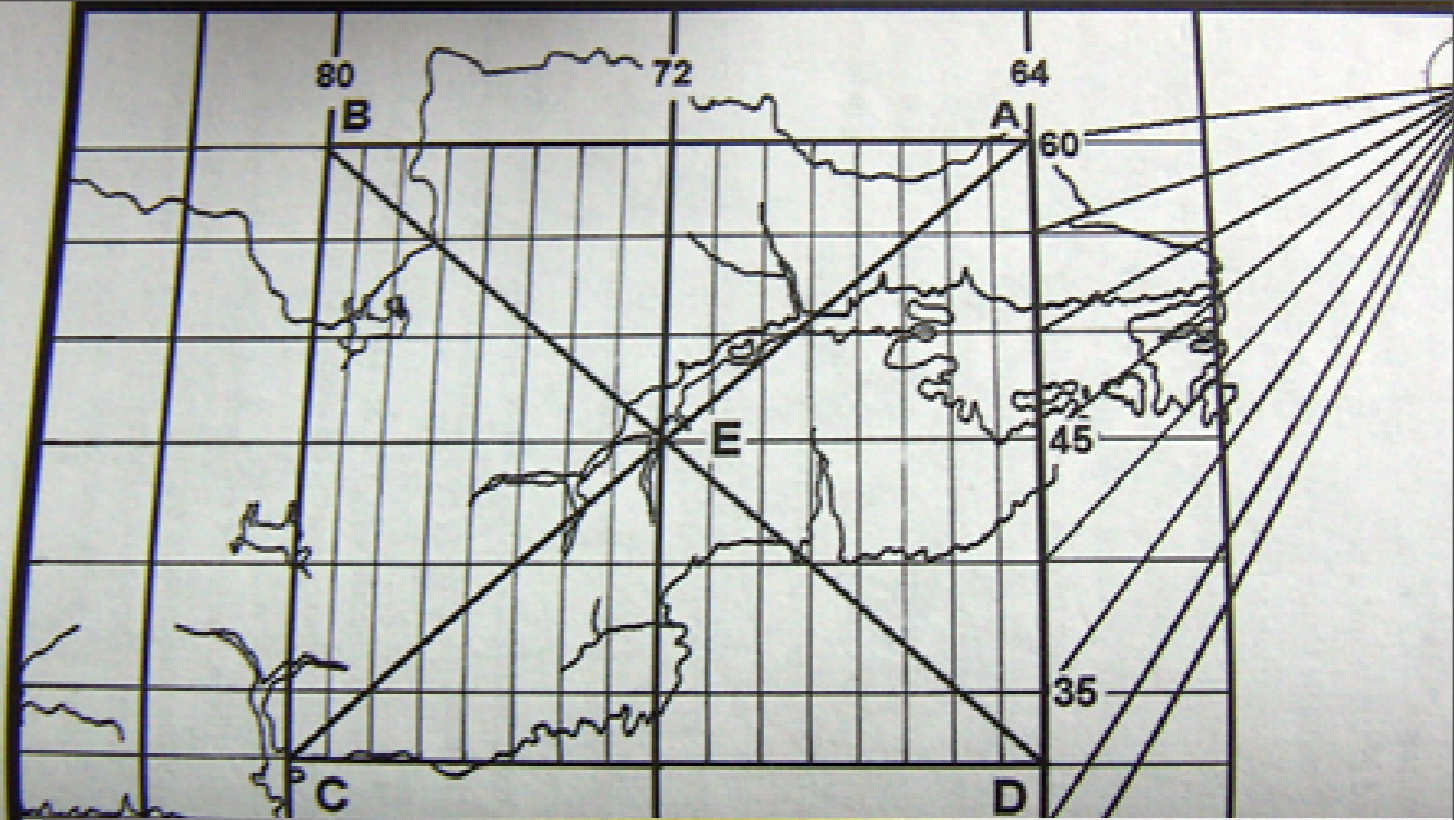
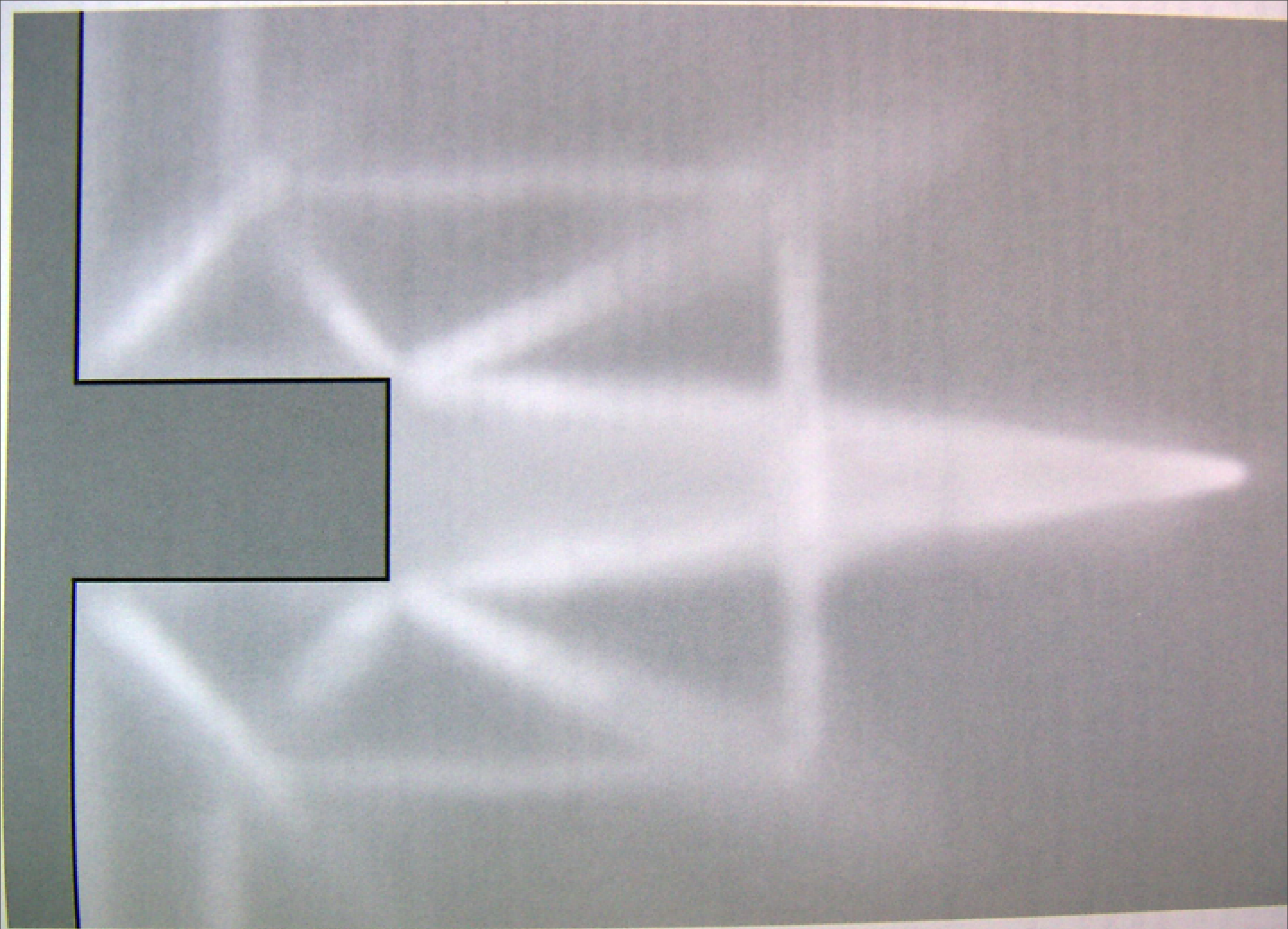

Fig. 3.8. A diagram depicting The Shepherds of Arcadia overlying a map of France. Note the coincidence of the cross formed by the longitudinal meridians. Original



Ark of the Covenant: Fractal (Recursive / "orgone") Capacitor for extracting voltage from gravity (requires fractal charge environment to work). Design: Sirius A, Application: Voltage source for the right fractal field to stabilize (make) mono-atom gold. (MFKZT / gold powder / manna / Ormes / 'spice' later called holy communion / shew bread.)

*Square wave  
Spark Gap.  
Harmonic Recursion  
.....the "Arc" of  
the "Ark"*

Akunatun stole this from Egypt when he changed his name to Moses to be the cash cow of his Essenes...

Augustine  
©03



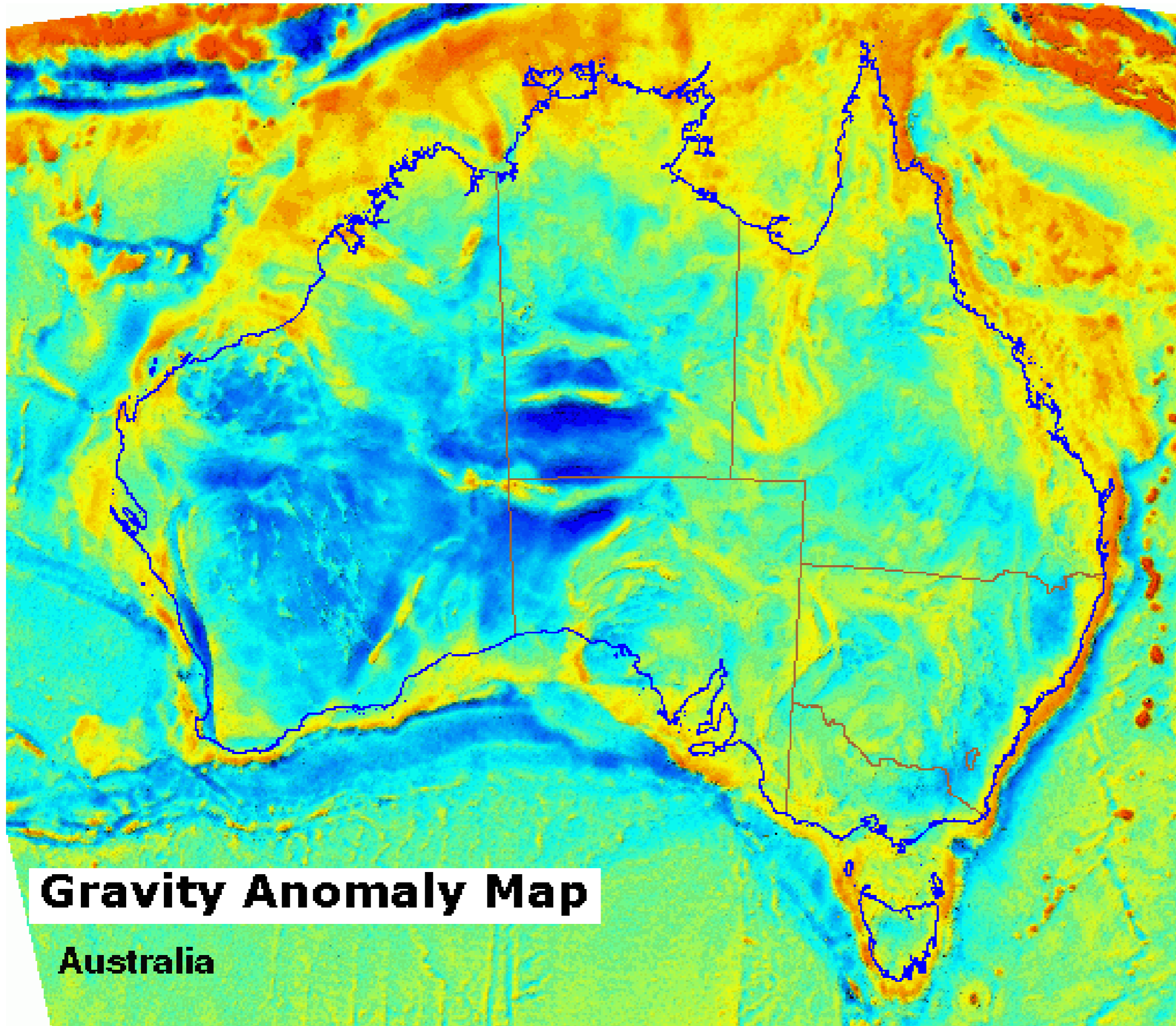

# Gravity Anomaly Map

Australia



## HF-Detector II PROFI (with Spectrumanalyser!)

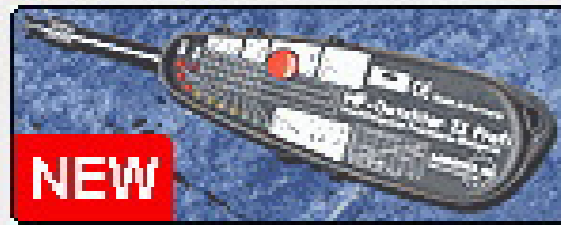

**NEW**

THE ultimate RF Field Strength Meter beats ALL other devices below 1000 €!. Based on Aaronias first GaAs-ASIC it offers ULTRA high sensitivity, super accuracy, [TÜV-Certification](#) , [Calibrated Antenna](#), switchable PEAK-Detector, Audio-Output and a PC-Connection. With our free [Spectrumanalyser-Software](#) it even offers a Spectrumanalyser so you can SEE and HEAR signals and pulsing!

Even less expensive if you order a [Detector-SET](#)

only 149,95

[Order / SET-Price](#)

Do you need further information ?

[DETAILED Information](#)

Quick Overview Measurement- and Frequency-Range main device:

dBm:	-70 dBm up to 0 dBm
Frequency:	3MHz up to 3GHz
Measurement-Range with included, calibrated Antenna (values are rounded):	
W/m <sup>2</sup> :	0,000.000.01 W/m <sup>2</sup> up to 0,1 W/m <sup>2</sup>
µW/cm <sup>2</sup> :	0,000.001 µW/cm <sup>2</sup> up to 10 µW/cm <sup>2</sup>
V/m:	0,002 V/m up to 7 V/m
A/m:	0,000.005 A/m up to 0,02 A/m

## Multidetector II PROFI / 1st Place Winner for 2000



For accurate EMF-measurements. Also offers a professional Frequency-Filter. ULTRA high sensitivity on all EMFs! THIS device offers all state-of-the-art functions for high precision measurements but can still be used by the laymen.

Even less expensive if you order a [Detector-SET](#)

only 99,95

[Order / SET-price](#)

Do you need further information ?

[DETAILED Information](#)

Quick Overview: Measuring and frequency ranges:

Magnetic-Field:	1 up to 10nT (0,01 up to 0,1mG)	10 up to 100nT (0,1 up to 1mG)	100 up to 1.000nT (1mG up to 10mG)	1.000 up to 10.000nT (10mG up to 100mG)
Electric-Field:	0,1 up to 1V/m	1 up to 10V/m	10 up to 100V/m	100 up to 1.000V/m
Frequency:	Filter 1: 5-500Hz (Low-Pass)			
	Filter 2: 500-400.000Hz (High-Pass)			

## Multidetector II

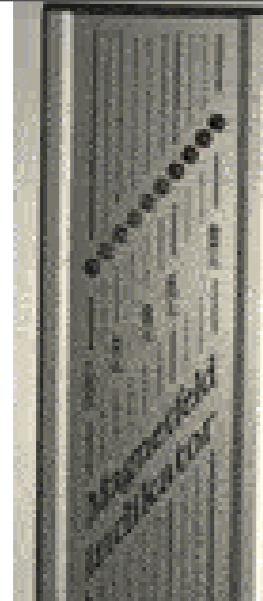

## Magnetfeld-Indikator (Cromm)

Eindimensionaler Indikator zur Feststellung von Abweichungen des magnetischen Gleichfeldes in vertikaler (Z-) Richtung. Durch Drehung des Gerätes sind auch Abweichungen der horizontalen Feldkomponenten (X oder Y-Richtung) nachweisbar.

- Anzeige: 10-stellige Leuchtdioden-Skala, **down to 1 nano tesla DC**
- Magnetfeldabweichungen gemäß Skala bis 4500 nT
- Akustische Kontrolle
- Gleichspannungsausgang 0 bis 1 V

[merkel-messtechnik.de](http://merkel-messtechnik.de)

**measures ley lines etc**

Artikel-Nr. 14 45 62

€ 290,00

Weak DC NanoTesla Field Effect  
Measure is useful outdoors.. Will  
indicate some ley telluric lines.

# COURANT D'EAU SOUTERRAIN (chartreuse d'Oujou)

26.09

- mesure des variations bioénergétiques en pourcent
- mesure de la variation de l'éther d'eau en pourcent
- mesure des variations du champ magnétique terrestre en nanotesla

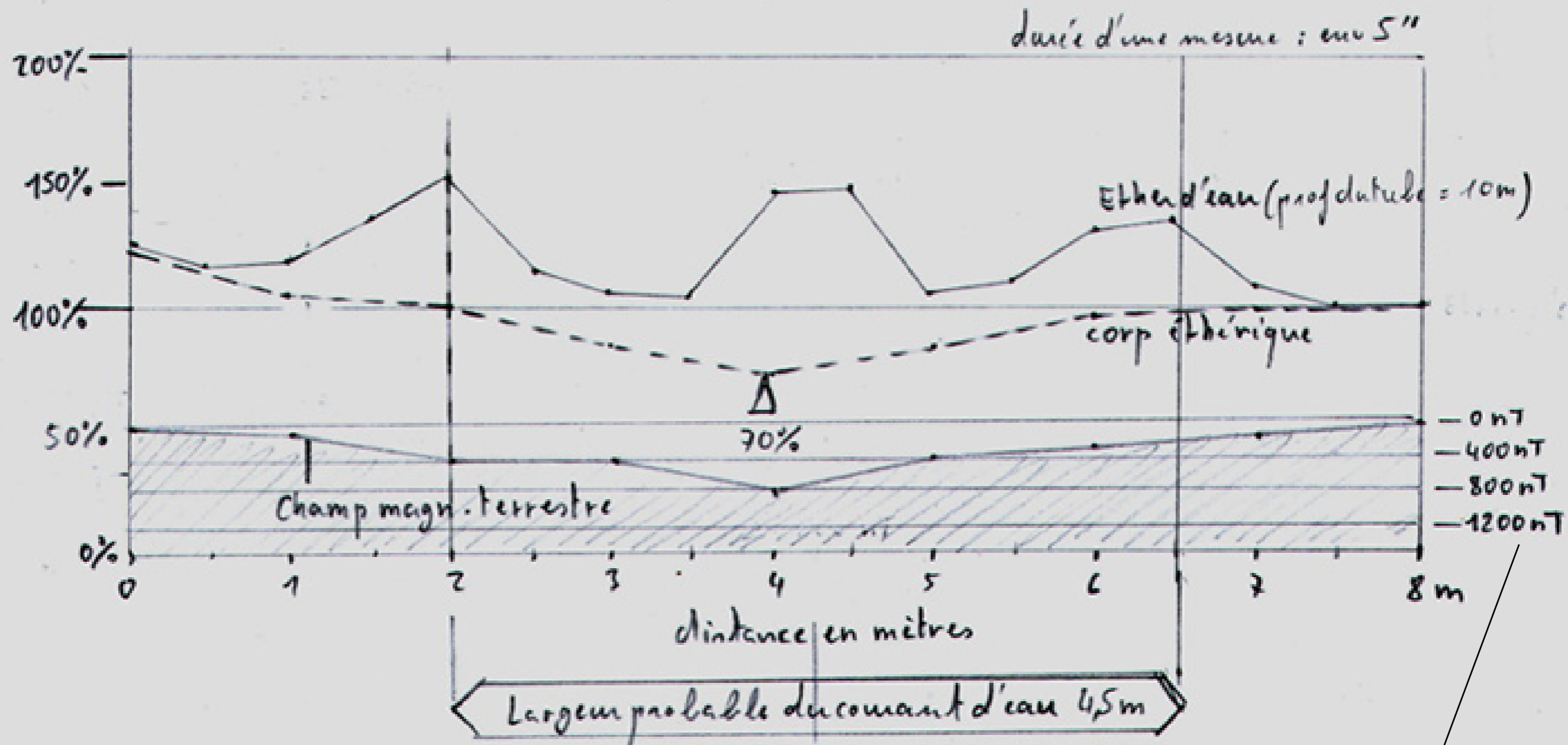

Underground Magnetic Current - Correlated to Actual NanoTesla  
Weak Magnetic Flux Measurements - with effect on Body Aura Size

# "Magnetic Map" Found to Guide Animal Migration

*Bijal P. Trivedi  
for National Geographic Today  
October 12, 2001*

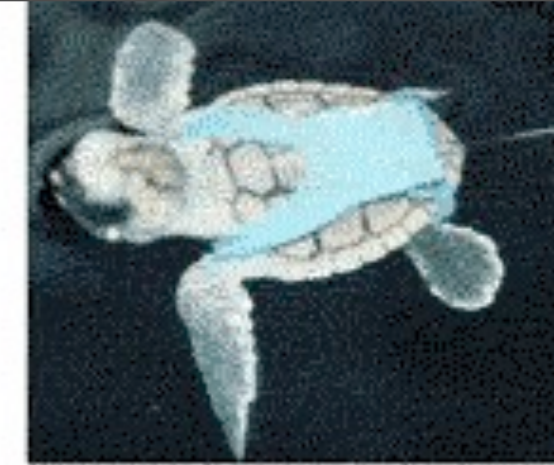

Tiny Traveler

Researchers outfitted loggerhead sea turtle hatchlings with blue harnesses tethered to an electronic tracking unit that recorded the turtles' position. The study was

Do you ever wonder why migrating animals such as birds, salmon, and whales, to name a few, never seem to meander off course and get lost? The answer, according to a couple of new studies, may be that those migration routes and navigation skills are hard-wired into the animals' brains.

Studies of loggerhead turtles revealed that hatchlings have an innate sense of the direction and strength of Earth's magnetic field, which they use for navigation and migration route.

## NEWS BYTES: Magnetic Map and Migration Seeing the Magnetic Map



Courtesy of Götz  
Schmiedeknecht

Bird placed in test funnel

### Seeing the Magnetic Map

European robins see the Earth's magnetic fields with their right eye to guide their seasonal migration.

Wolfgang Wiltschko at Goethe-Universität and his colleagues at Ruhr-Universität, Germany, tested each eye of the European robins and found that magnetoreception is dependent on right eye input.

In birds, detecting magnetic fields depends on the visual system. The retina may contain both visible light sensors and magnetic field sensors. Both kinds of sensors activate neurons within the visual signaling pathway.

The right eye sends its information to the left hemisphere of the brain. Seeing the magnetic map is a left brain function.

*cicada*  
 Violino I  
*cicada*  
 Violino II  
*coyote*  
 Viola  
*owl*  
 Violoncello  
*bullfrog*  
 Contrabasso

**BIO-ACOUSTICS**  
*Habitat ambience & Ecological balance*

BY BERNARD L. KRAUSE, Ph.D.

**T**HE PURELY BIOLOGICAL AMBIENT sounds of our habitat are extremely hard to find these days. All but obscured by human-induced masking noise, these creature voices are trying to tell us in their own way something we haven't yet learned. The message is subtle. The theme is life, itself. R. Murray Schafer, the Canadian sound environmentalist who worked on the World Soundscape Project during the '70s, said in reference to the importance of sound in our lives, "Everything that...

to emulate the sounds of birds and land animals. They had learned what animals instinctively knew. Their lives often depended on sound as well as sight. Even when there was little or no light, a message could always be transmitted through the air by sound. Aristotle was the first Western person to write about sounds underwater. And 2,000 years later, Leonardo da Vinci (1452-1519) found a way to hear the sound of ships at a distance and very probably the sound of marine mammals...

- BioAcoustic Habitat Theory: Forest Makes A Membrane (Immune System) by Braiding Coherent Sound Layers..

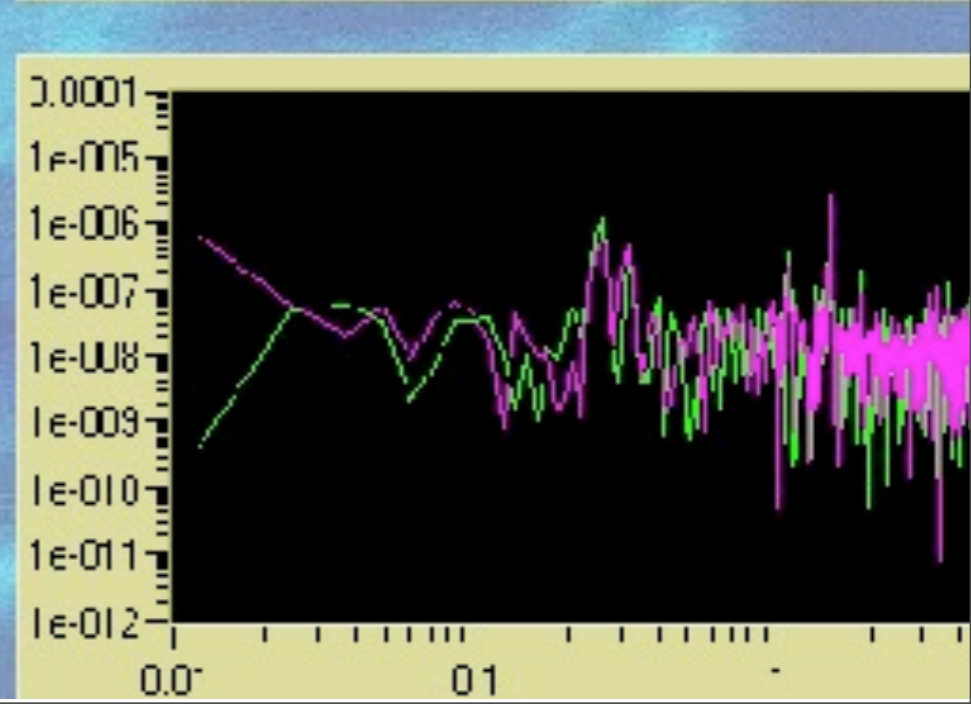
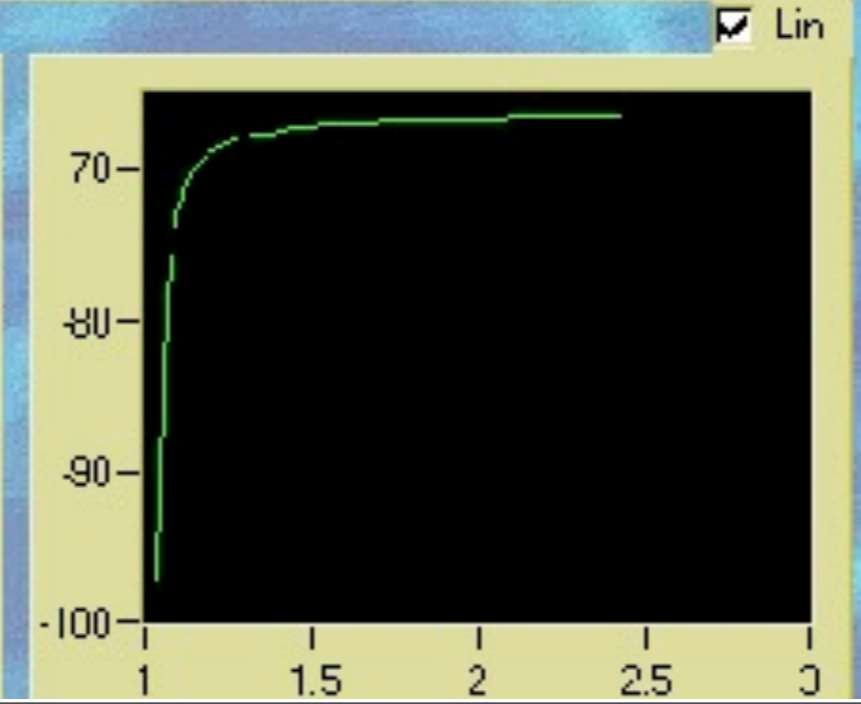
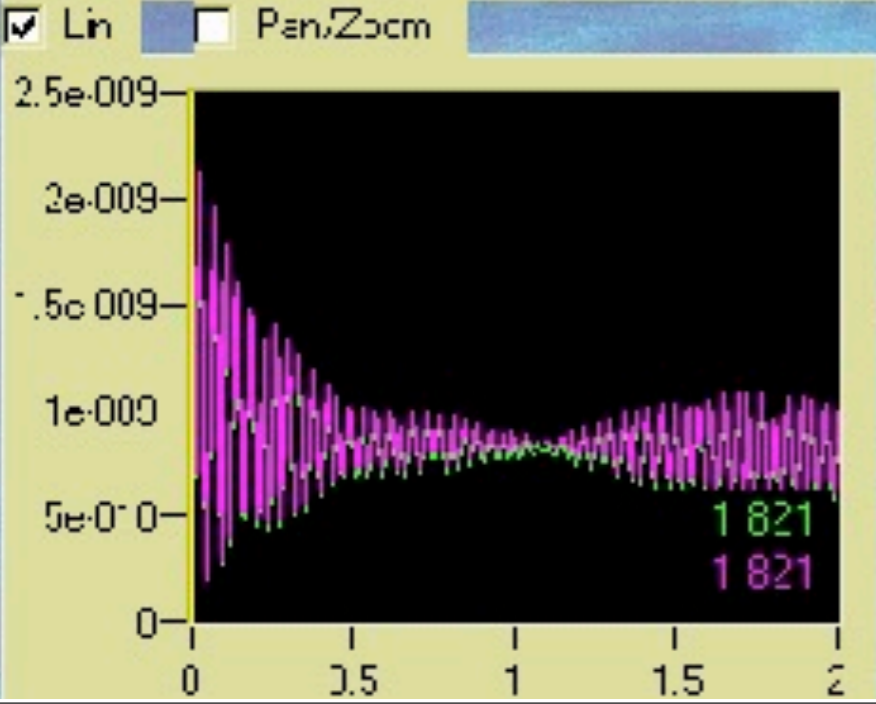
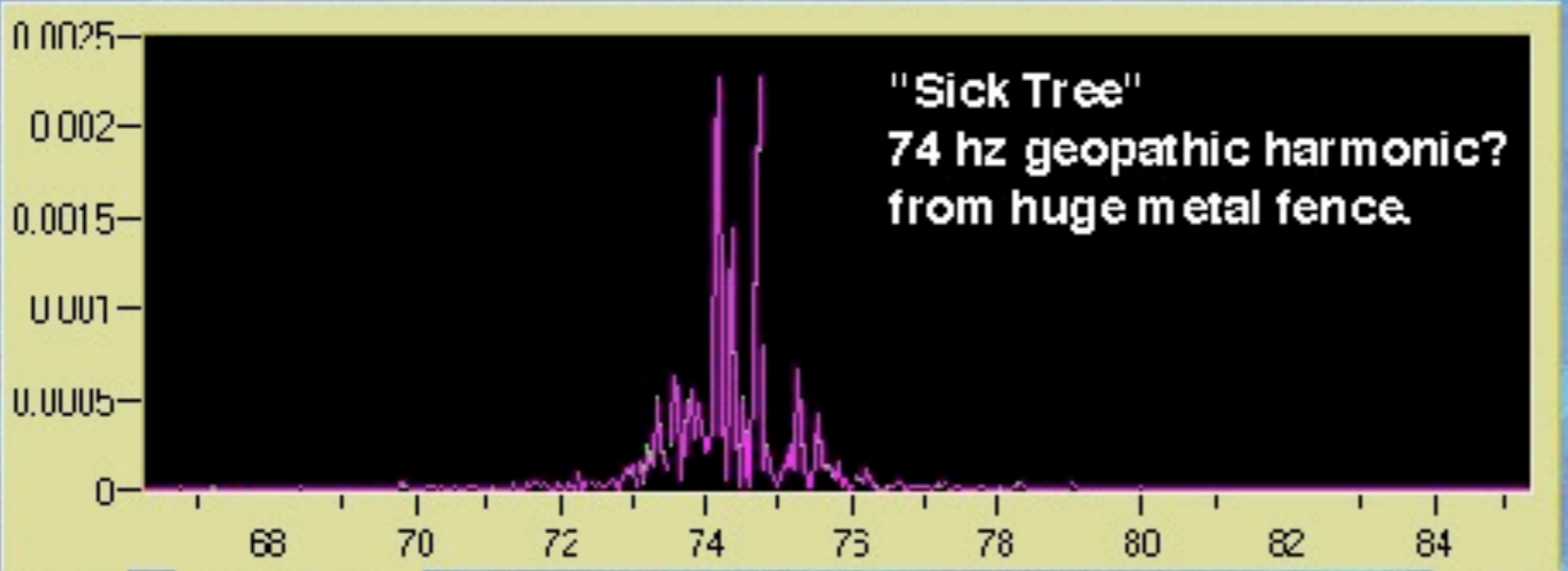
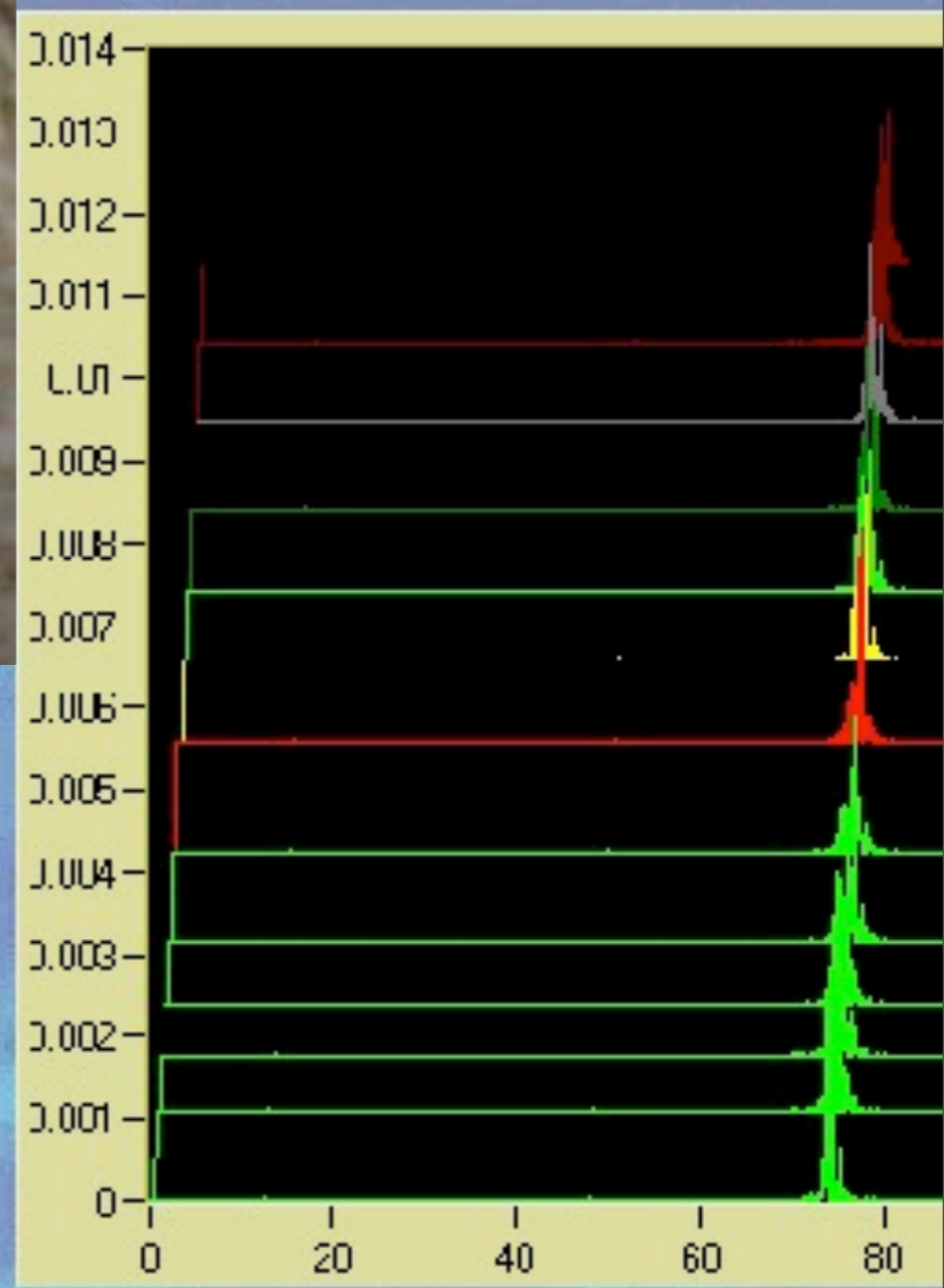
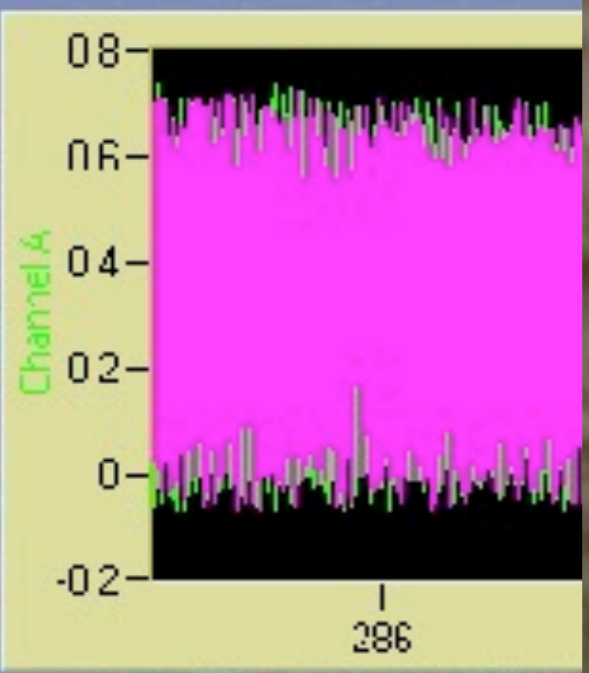



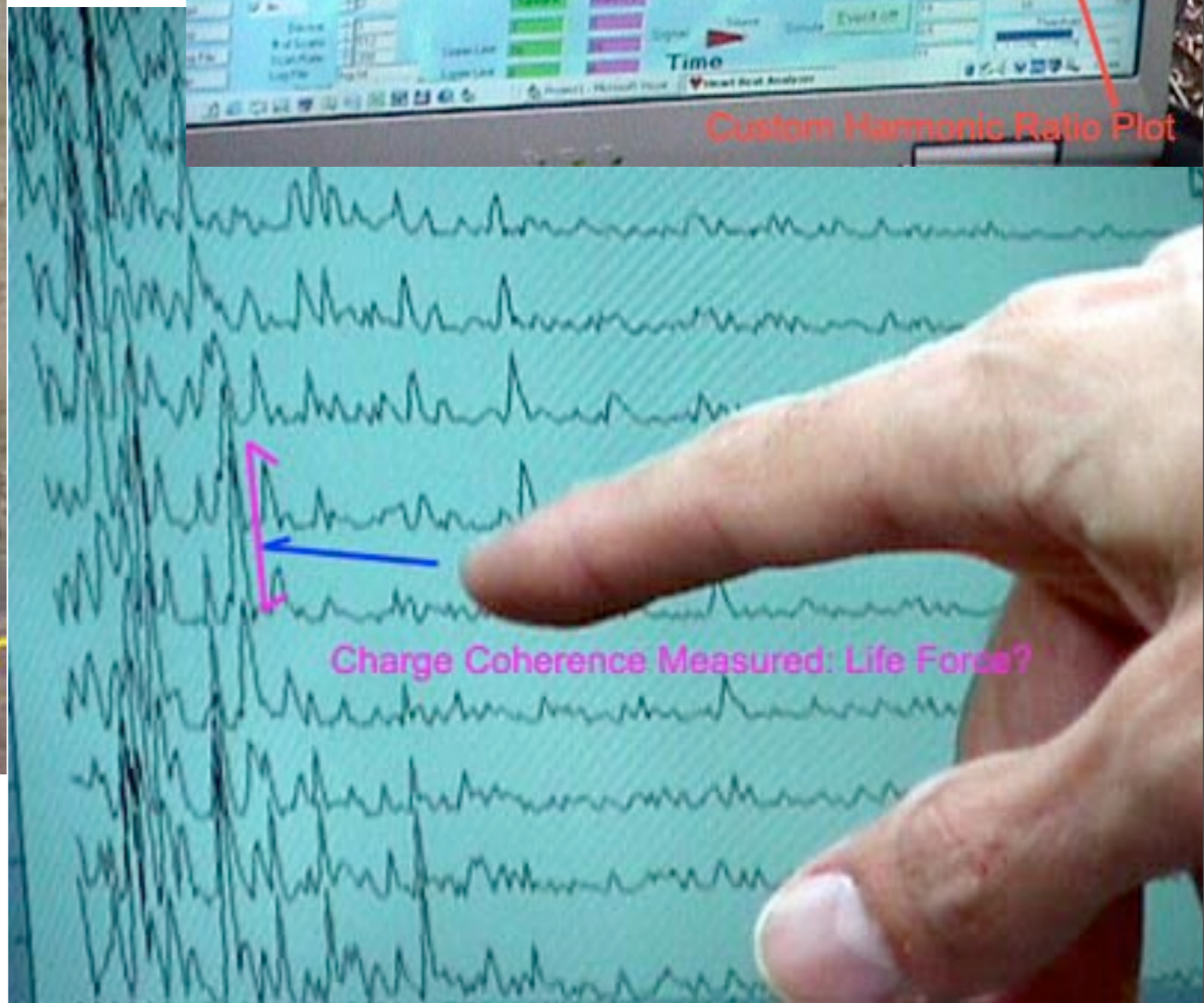
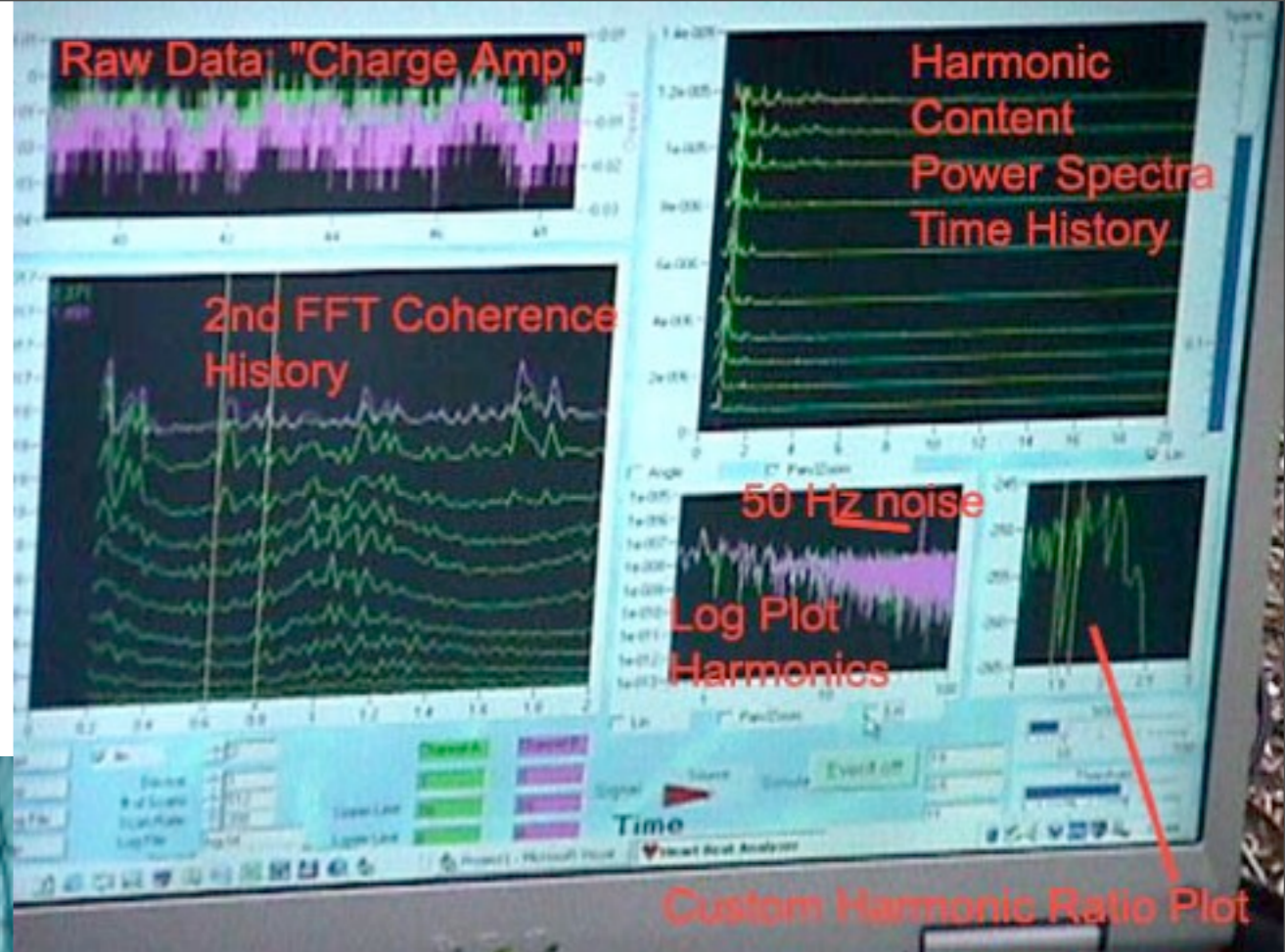

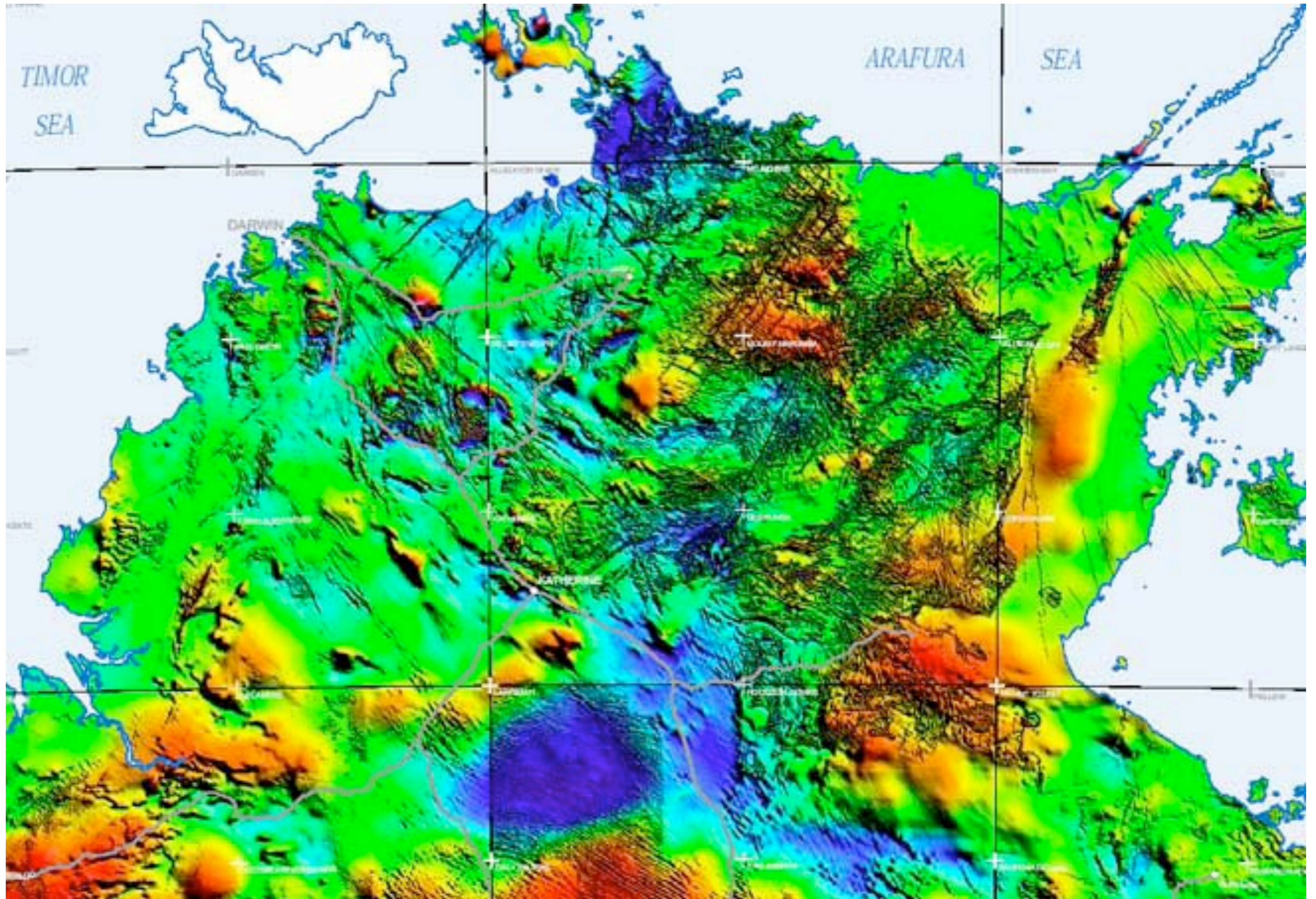

# Magnetic Anomaly Map of Australia

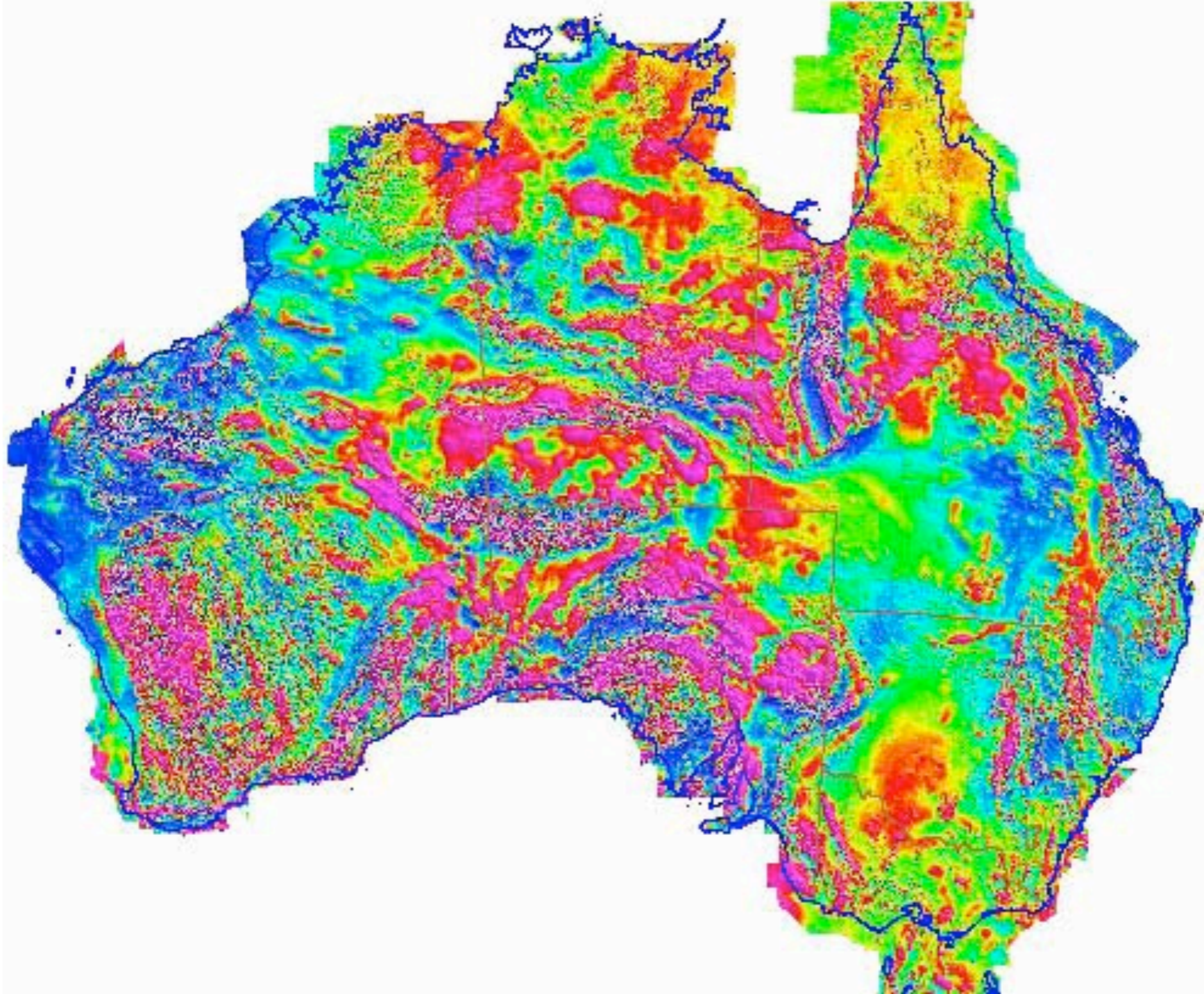

**Magnetic  
Flux  
Density  
Emission  
Map  
Reveals  
Population  
Centers  
Location  
&  
Mineral  
Of  
Water**

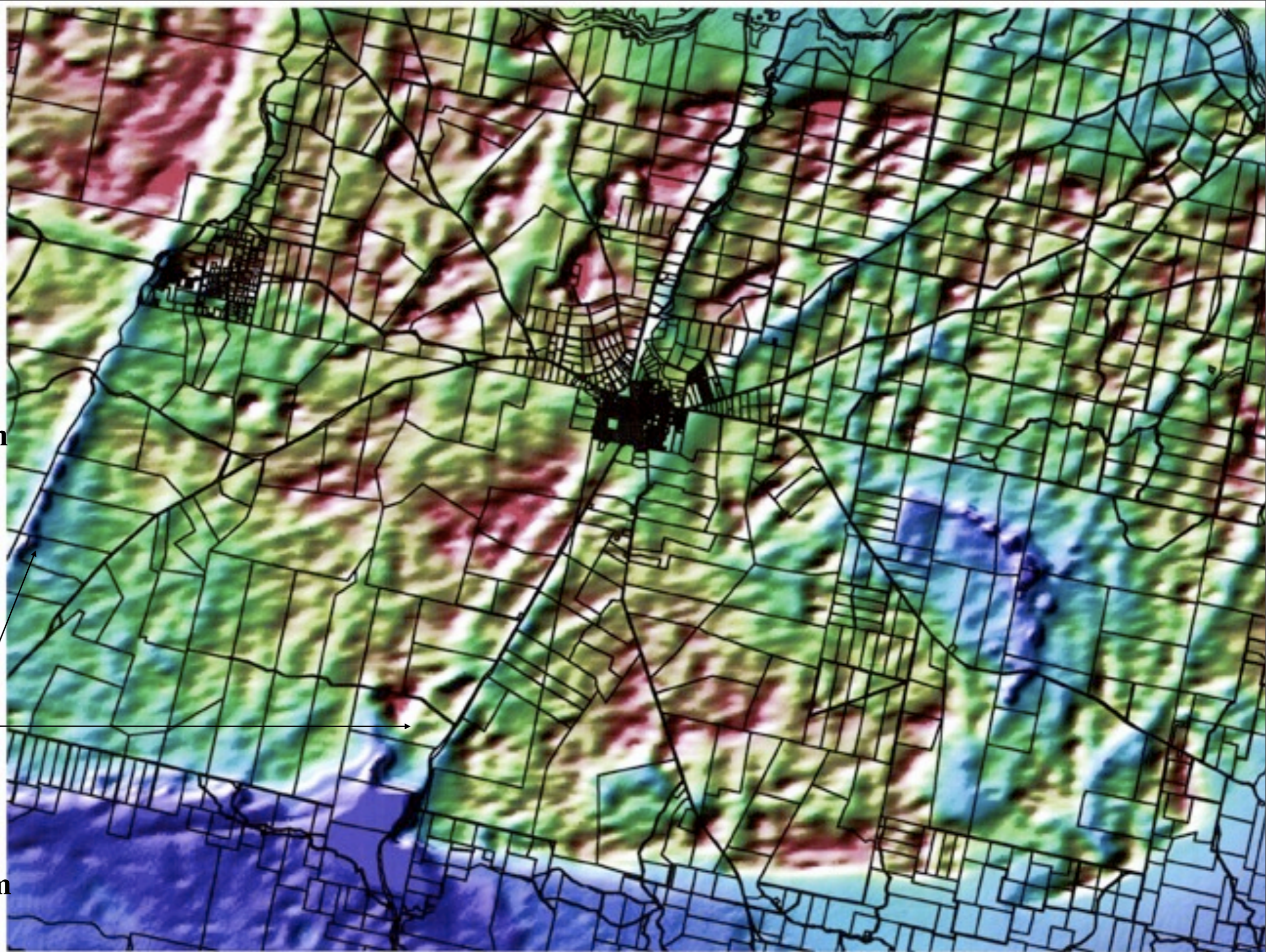

**Braidwood - Enhanced Magnetics  
AND  
Rob Gourlay orbtek@austarnet.com.au**

Braidwood Golf/Bowls Club Enhanced Magnetics  
Map prepared by Natural Resource  
Intelligence Pty Ltd (NRI)  
February 2008, using TNTmips (GIS)



**RESHEL/TECHAD (ISIS EYE)  
3RD BREASTPLATE OF METATRON**

INCLUDES OTHER BREASTPLATES:  
 "PYRALIUM" (STAR TETRAHEDRON)  
 "JOHANOUS" (STELLAR, PENTA-DOVE)  
 "EYE OF RA" (RHOMBIC TIME GATES, ETC.)  
 FEMALE HALF SHOWN HERE

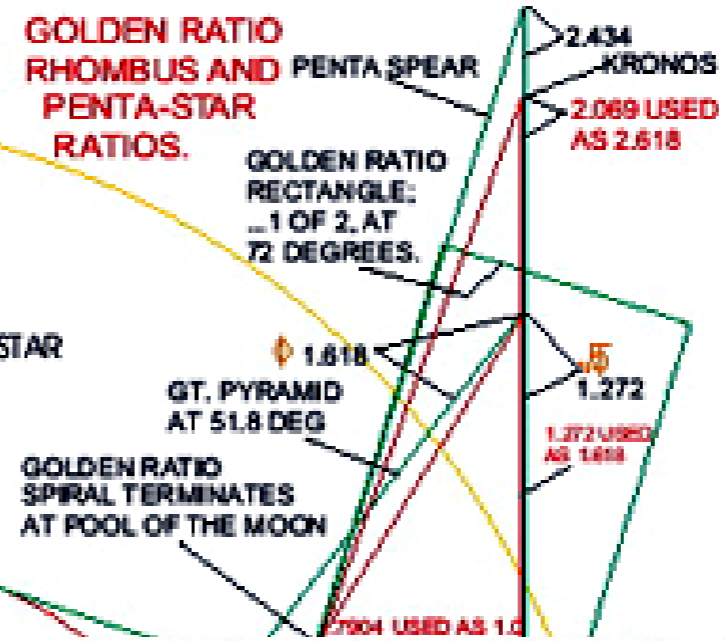

**SYSTEMS IN ORDER OF MANIFESTATION:**

- PENTAGON:** SEED; OUT OF TIME; 2ND M...
- RHOMBUS:** GOLDEN RATIO, TIME GATE, EYE OF RA, LOW FRE...
- HAEPATHIA:** TETRAHEDRON: HEART OF GOD, CONNECTIVES, P...
- TETRAHEDRON, PHYSICAL CONFIG., APEX**
- GREAT PYRAMID:** GOLDEN RATIO SPIRAL...
- GRAIL:** (RESH) COMPOSITE CUPS, GREAT STEP TWO PILLARS
- CHAMBER OF THE SON/DAU.:** "GRAIL HOST"
- TELEPLANE (TEMPORAL REALITY FRAME):** ULTA POLE INTERFACE
- POOLS OF THE MOON/LIFE:** LIFE INTO CREATED FORM (TWO
- UNIFIED PYRAMID AND TETRAHEDRON**
- SHIYN POLE INTERFACES WITH NEUTRA...**

SYSTEMS IN ORD  
 PENTAGON:  
 RHOMBUS  
 HAEPATHIA:  
 TETRAHEDRON,  
 GREAT PYRAMID  
 GRAIL:  
 CHAMBER OF TH  
 TELEPLANE  
 SEED; OUT OF TIM  
 DESCENDS FROM  
 GOLDEN RATIO, I  
 TETRAHEDRON: I  
 PHYSICAL CONFI  
 GOLDEN RATIO S  
 (RESH) COMPOSIF  
 GRAIL HOST  
 (TEMPORAL REAL  
 LIFE INTO CREAT  
 TO MOVE PAST TI  
 OF NO RETURN,  
 POOLS OF THE M  
 UNIFIED PYRAMI  
 SHIYN POLE INTE

EYE OF RA,  
 GOLDEN RATIO  
 RHOMBUS  
 SOLAR IS  
 RING  
 SOLAR ATS  
 RING  
 TUATH  
 RING

72 DEG. ANGLE  
 GOLDEN RATIO RECTANGLE  
 ...ONE FOR EACH SPIRAL,  
 ONLY ONE SHOWN.

SYSTEMS IN ORDER OF MANIFESTATION

# Ode to My Bundgelong Auntie (Elder)- Lorraine Mafi Williams

Cape York

The rocks in the bay, always black before my eyes.  
Started turnin white - on the day she passed away.  
From the summit of the northern slope of the southern peak.  
As she was passing over, before she was laid to rest,  
So to; the northern rock was lit  
Up on the ridge where the north and south winds meet,  
I saw her radiant and child like face.  
And these words I heard her speak:  
"It's only for eyes that can see, Grace, only for eyes that can see."  
I knew she had fulfilled her task, to open up the line,  
And in that moment of understanding, something deep sunk in.  
Before my eyes a luminous light that traveled a great speed,  
eminated from those rocks up to the top  
and all the points around this vast land.  
The day they took her body back up the story line to Woodenbong  
The winds came up behind her and the rain it pelted down.  
As if the Mother Earth herself would cleanse this Rainbow Land.  
And deeply mourn the passing  
of another great custodian of Old Gondwana Land.

Magnetic  
Song  
Line  
Dream  
Track  
called  
"Yurrumbul"  
meaning  
Rainbow  
Serpent  
in  
Gugu Yalangi

Wilson's Promontory

COMMAND CIRCUIT 9.10/10.9  
TO HARVEST GOD'S EARTH

ALL SOLUTIONS ARE ONE SOLUTION  
IN THE UNIFIED FIELD OF E=MC<sup>2</sup>.  
ALL RIVERS RUN INTO THE COSMIC SEA.  
IT IS THE PLACE WHERE SCIENCE,  
RELIGION, PHILOSOPHY, PSYCHOLOGY,  
GEOMETRY, ART, AND MUSIC IS ONE.

THE KING OF KINGS IS HERE-NOW WITH  
THE COMPLETE SOLUTION TO EVERY  
MATTER THAT HAS EVER BUCKLED MAN.

**E=MC<sup>2</sup>**

**G R A V I T Y . C O D E**

**IMPLOSION: Key to BLISS, PASSION and ENLIGHTEN**  
The FIRE of Passion comes from the Heart,  
It is measurable in the EKG as COHERENCE  
and the music of Golden Mean.

It is the key to all energy crises, yet simply depend  
Understanding the PRINCIPLE of IMPLOSION.

*This fire is what makes your energy field self steer*

**The KEY to eliminating all the polluting technologies on Earth which create transport:**

Charge in a fractal creates gravity because wave velocities beating or hetero acceleration produced is the ONLY source of gravity. (Also the solution to phase c

The amount of **self similarity** at the fundamental wave symmetry level between nucleus of an atom for example) - will predict the amount of gravity it generates mass, because fractality permits the charge compression which allows inertia to b

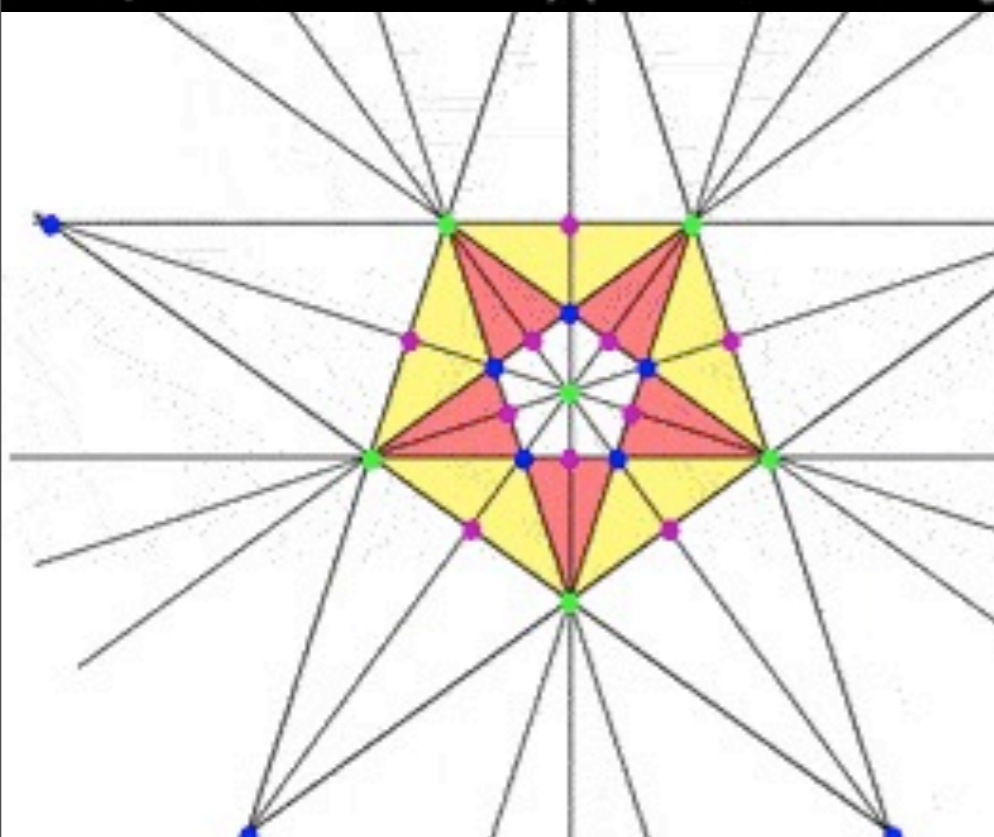

Al-Khem =Ability to Make BLACK Hole..(IMPLODE) [soulinvitation.com/alchemy](http://soulinvitation.com/alchemy)

Khem=Egyptian for “Blackness” (ThuthMoses=Sons of Thoth/Enki-Blue/Black Rigelian Blood)

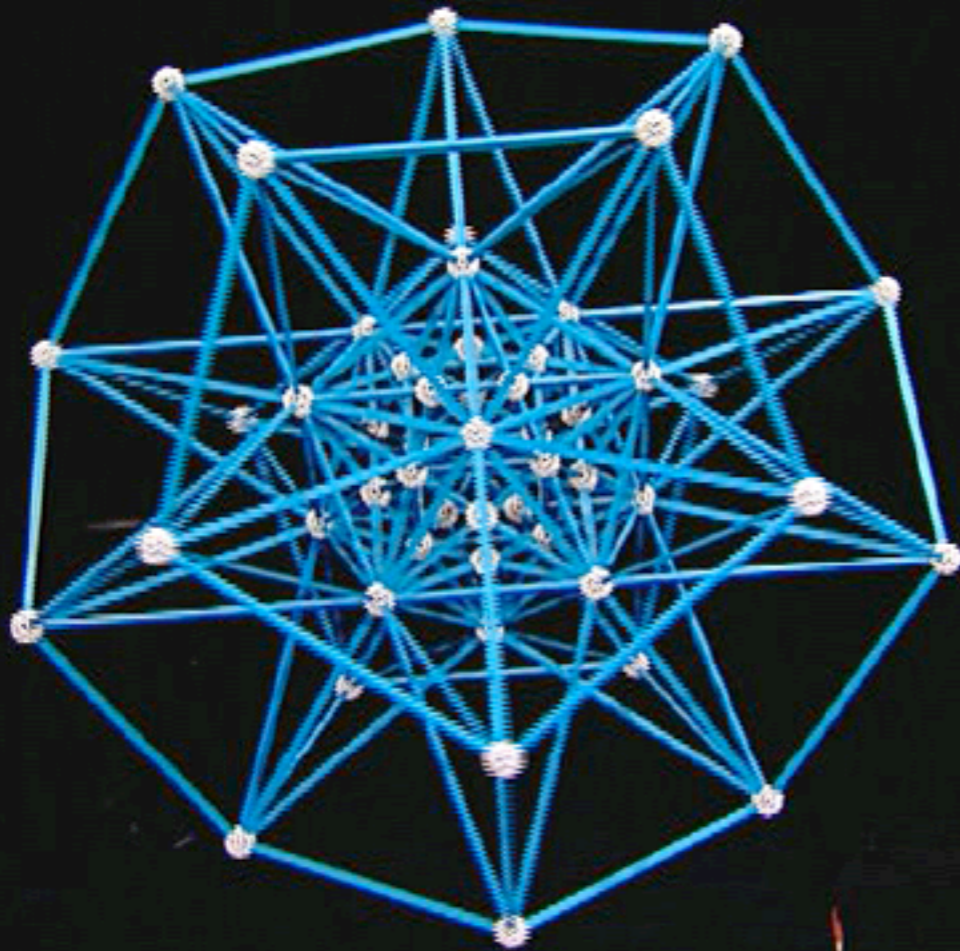

### Implosive

(Golden Ratio) Symmetry of Gold

(+Palladium +PGM Metals)

(Electron Shells

Self Similar/Fractal to Nucleus)

*X,Y,Z Coordinate of each Dodec / Icos*

*Wave Node in this Infinite 3D Fractal*

*Nest - is each a simple multiple of*

*Golden Ratio..(Implosive to Center Electrically)*

Kepler's Model

Solar Planets

Orbital ratios..

Dodeca

(Golden Ratio)

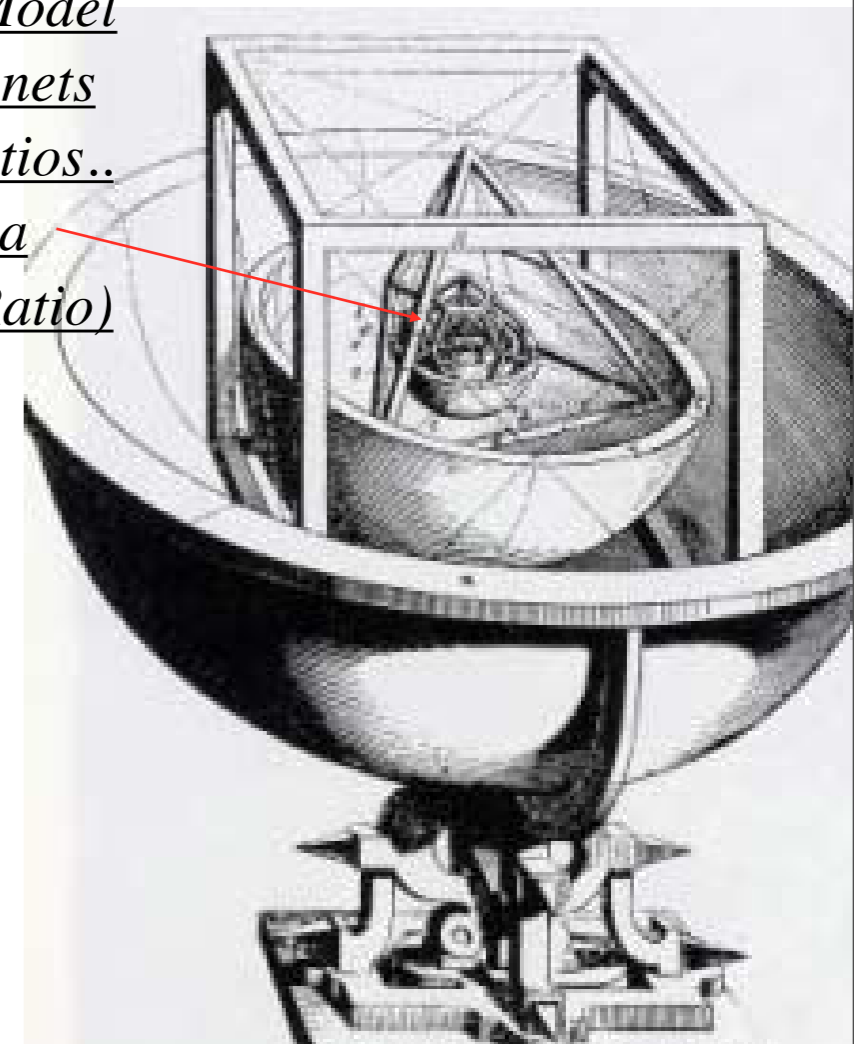

**Charge Self Similarity-CAUSES/Stabilizes Gravity**

Ref: [soulinvitation.com/gravitycause](http://soulinvitation.com/gravitycause)

**Therefore Kepler / Rudolf / Tyco Brahe**

**were essentially correct!**

**-Modeling the Solar System by**

**Platonic (Golden Ratio ) Perfect NESTING..**

**(Gravity Stabilizing because infinite recursive**

**Constructive Charge collapse - DEFINES Gravity !**



# SPIRA SOLARIS ARCHYTAS-MIRABILIS

ref: [www.spirasolaris.ca](http://www.spirasolaris.ca)

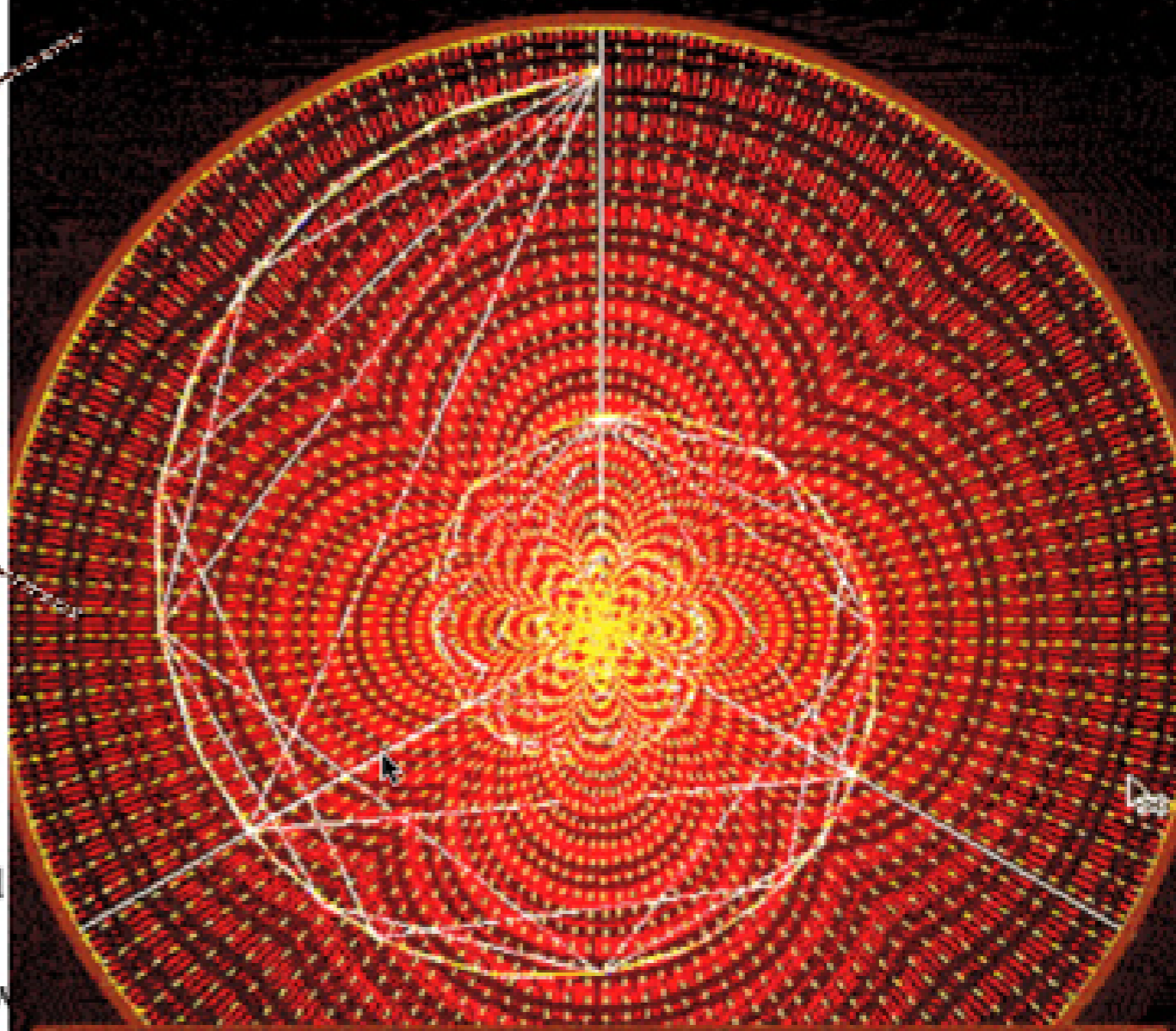
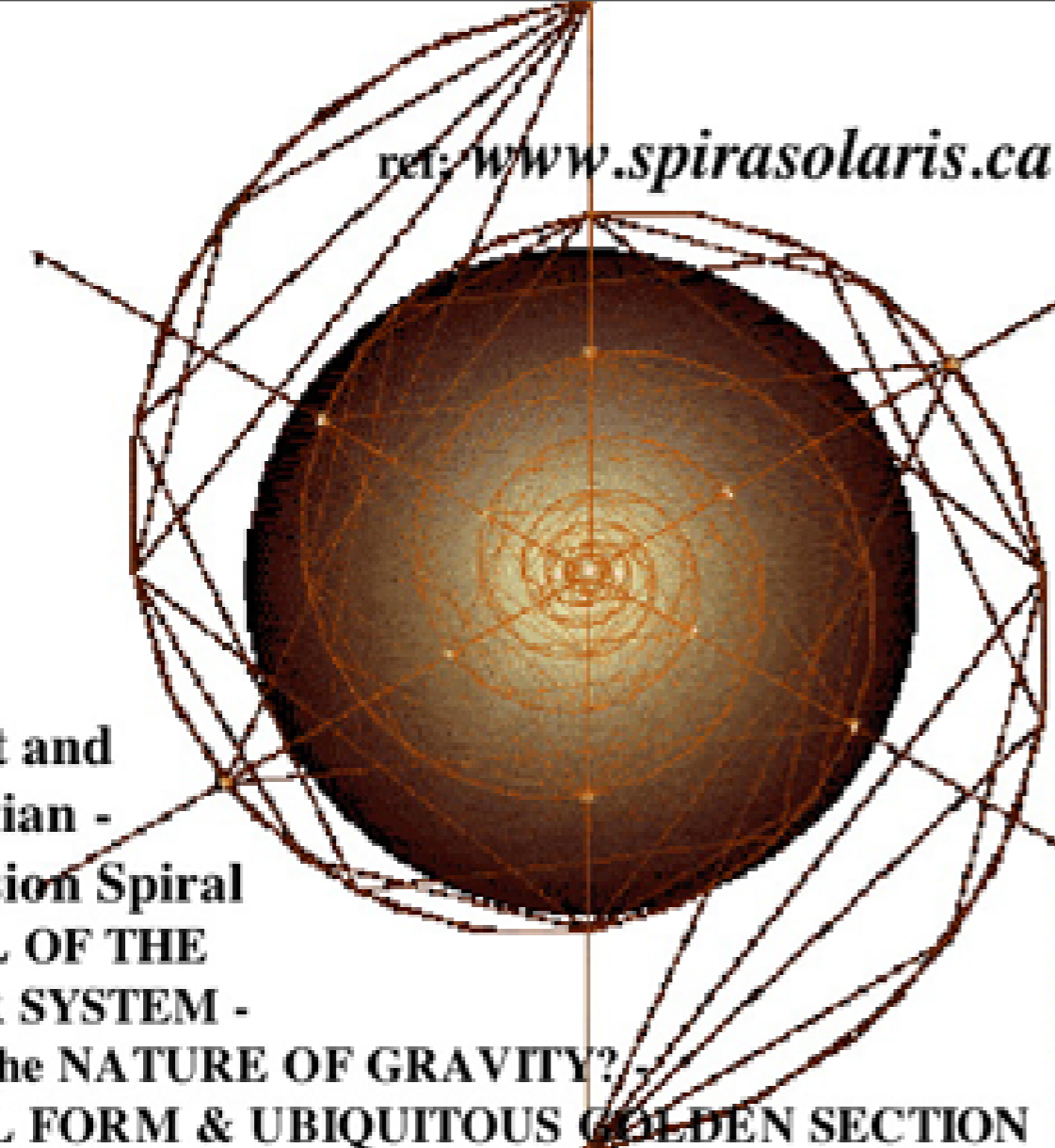

**Ancient and  
Keplerian -  
Recursion Spiral  
MODEL OF THE  
SOLAR SYSTEM -**

**Proves the NATURE OF GRAVITY? -  
SPIRAL FORM & UBIQUITOUS GOLDEN SECTION**

IV Spira Solaris Archytas-Mirabilis Most suitably represented  
in terms of exponential growth and a complex equiangular  
spiral, the Phi-series based planetary model appears to be new  
in one sense and yet quite ancient in another

**THE EXPONENTIAL PLANETARY FRAMEWORK:**  
Bode's Flaw Bode's "Law" -the Titius-Bode relationship -  
for approximating mean planetary distances originated by  
Johann Titius in 1866 & popularized by Johann Bode in 1871.  
The " law " later failed in the cases of the outermost planets

Neptune and Pluto... flawed from the outset with respect to distances of both MERCURY and EARTH, as Titius was  
perhaps aware. The Alternative Describes an alternative approach to the structure of the Solar System that employs  
logarithmic data, orbital velocity, synodic motion, and mean planetary periods and the use of mean heliocentric distances  
alone. **The Exponential Order The constant of linearity for the resulting planetary framework is the constant Phi**

**"For in the Whole World Shinneth the Triad  
Over which the Monad Rules.  
This Order is the Beginning of All Section"  
THE CHALDEAN ORACLES**

# The Dodecahedron Is the Symmetry of Perfect Self-Embedding & Self-Similarity.

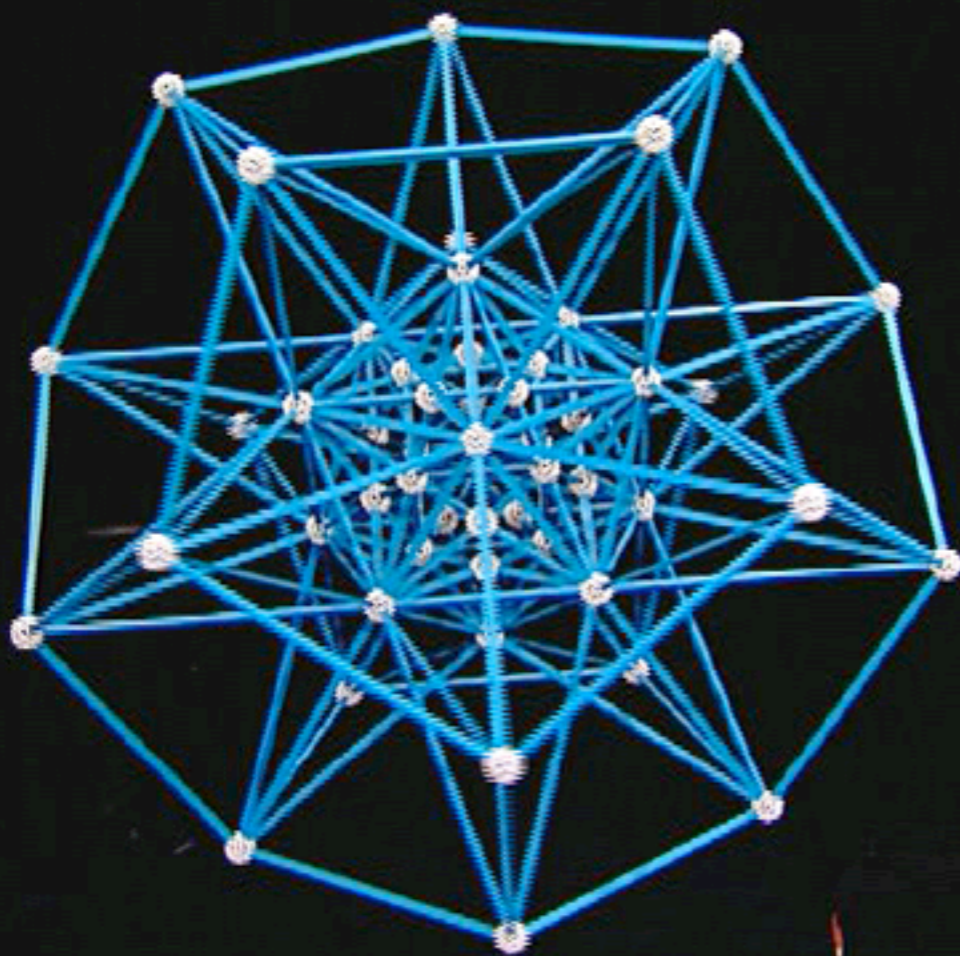

Palladium's  
Dodeca  
Nuclear  
Symmetry  
Is the KEY  
To "Cold"  
Fusion



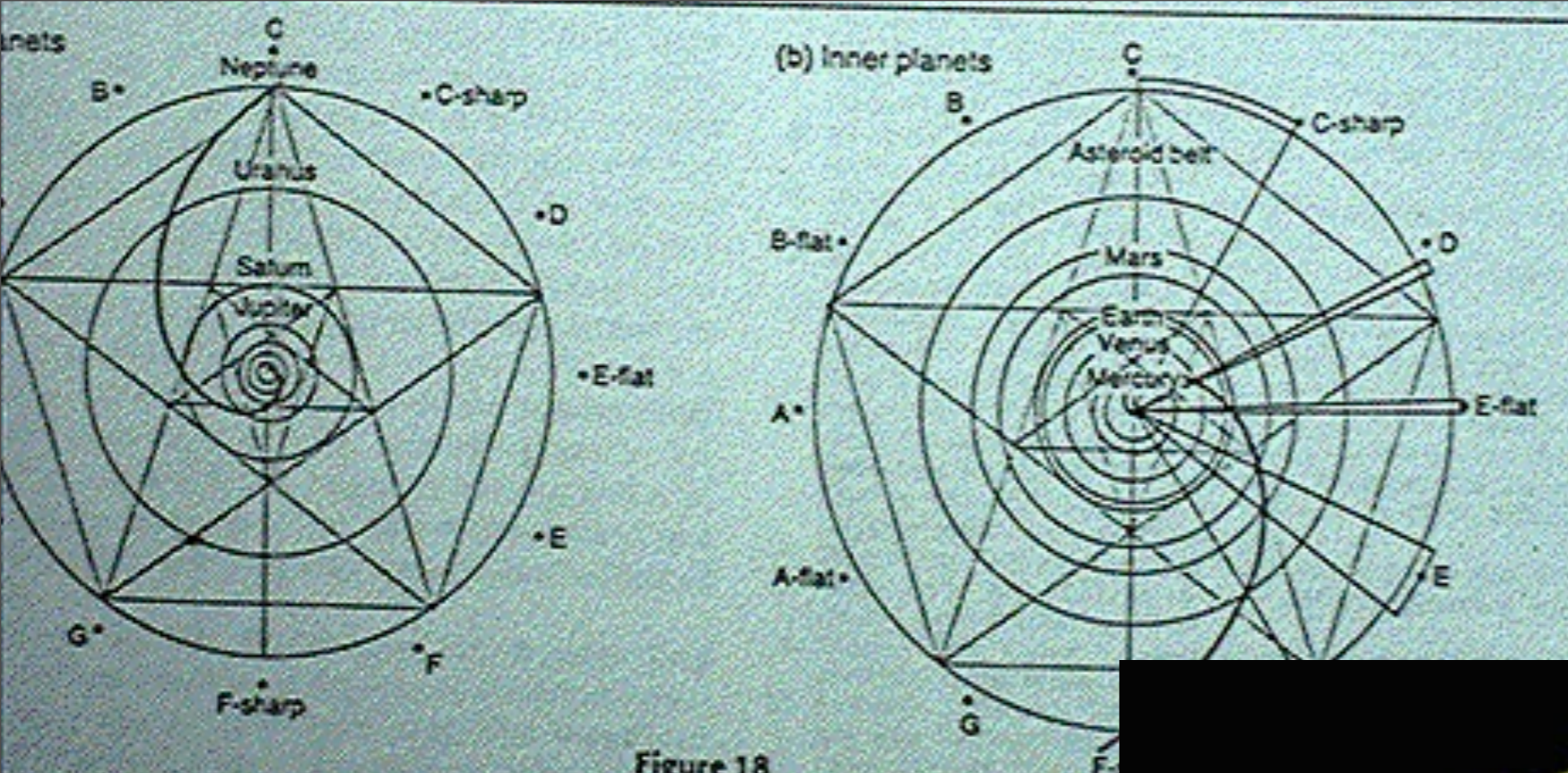
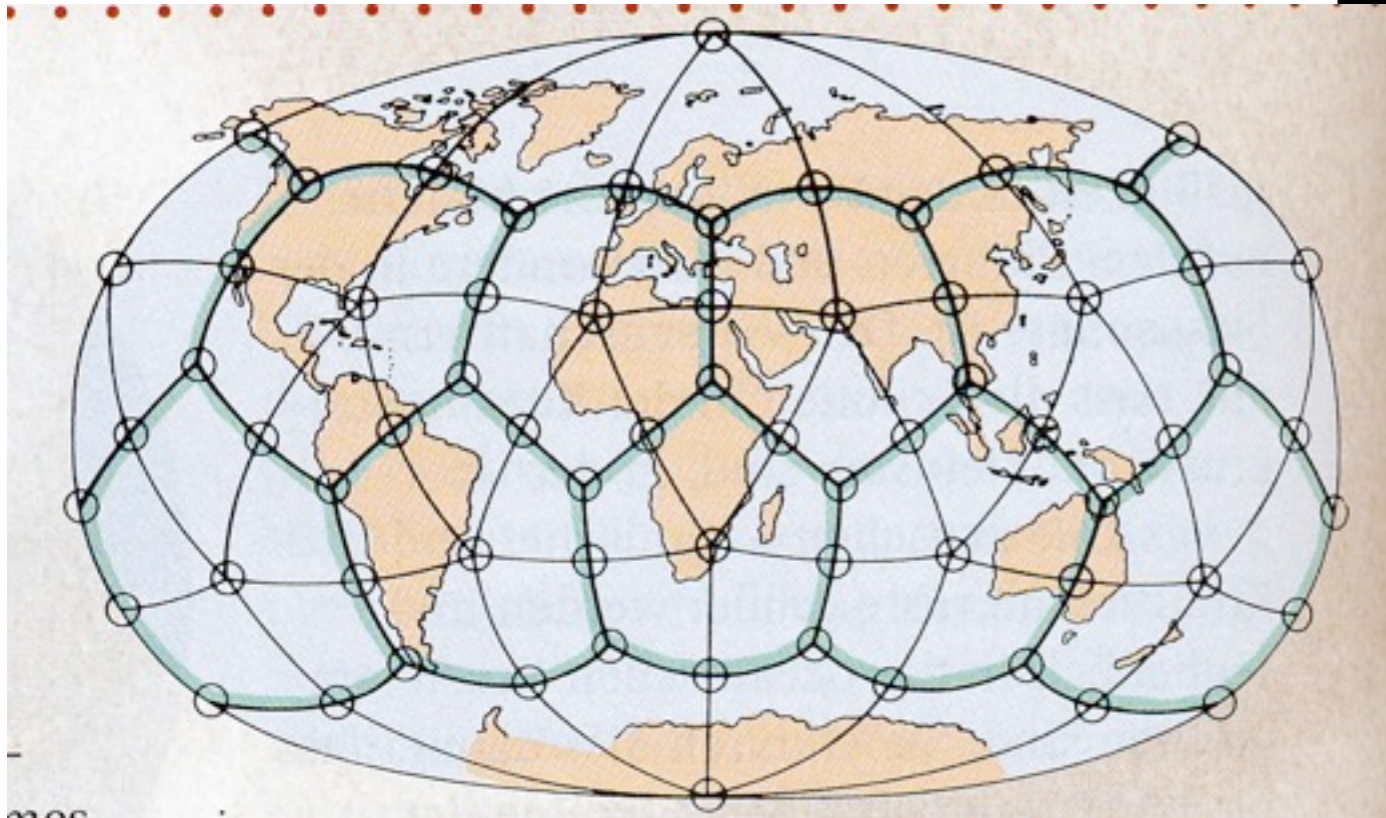
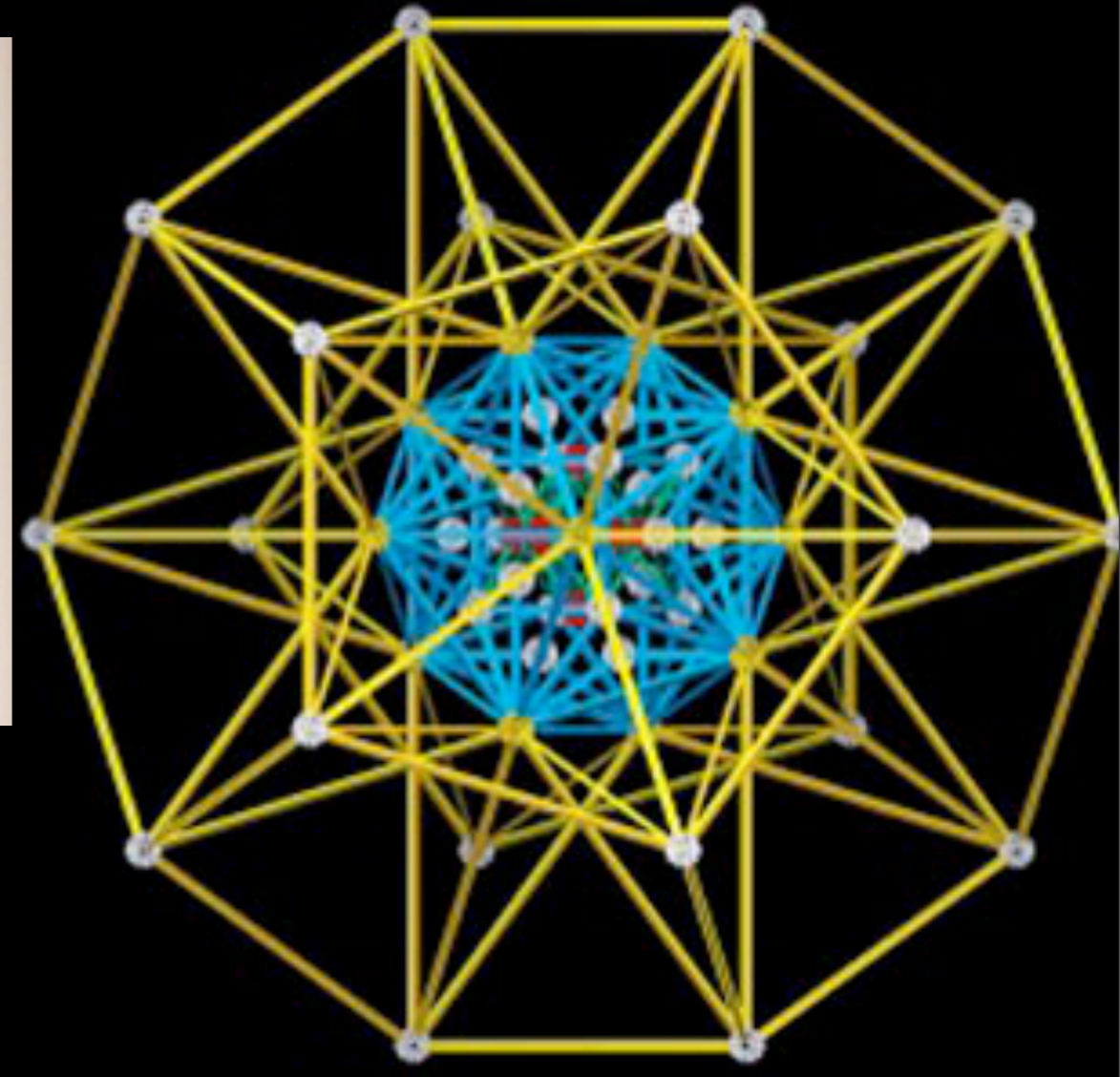
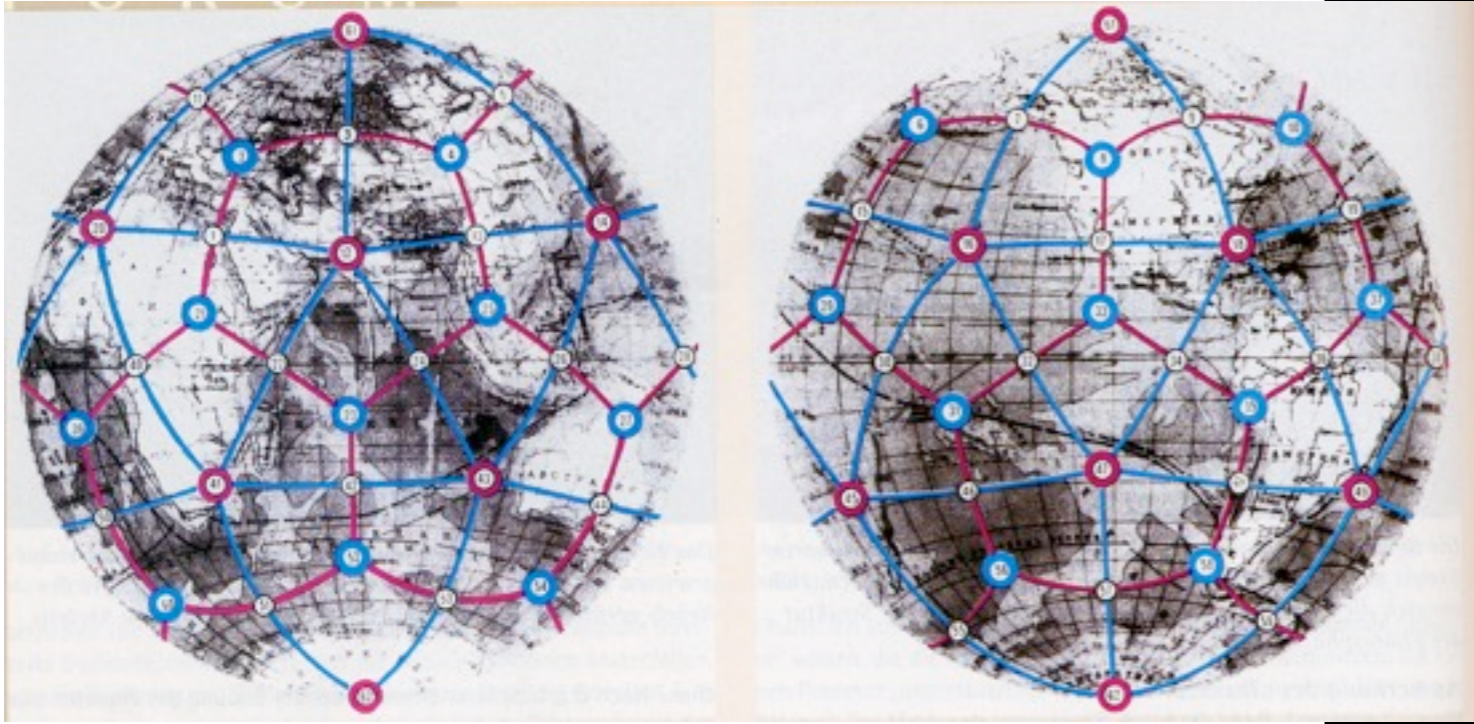

Figure 18

THE GOLDEN MEAN PROPORTIONS OF THE SOLAR SYSTEM  
 The mean proportions of the solar system are shown by the following construction in the orbit of Neptune. Draw the diagonals of this pentagon; a smaller pentagon is inscribed in the orbit of Saturn. The next smaller pentagon, generated from the diagonals of the orbit of the Asteroid belt. If we now inscribe a further pentagon inside the outermost of its first "daughter" pentagon exactly circumscribes the orbit of the Earth.



# Kristallplanet



# Harmonikalik

Kepler's Model

Solar Planets

Orbital ratios..

Dodeca

(Golden Ratio)

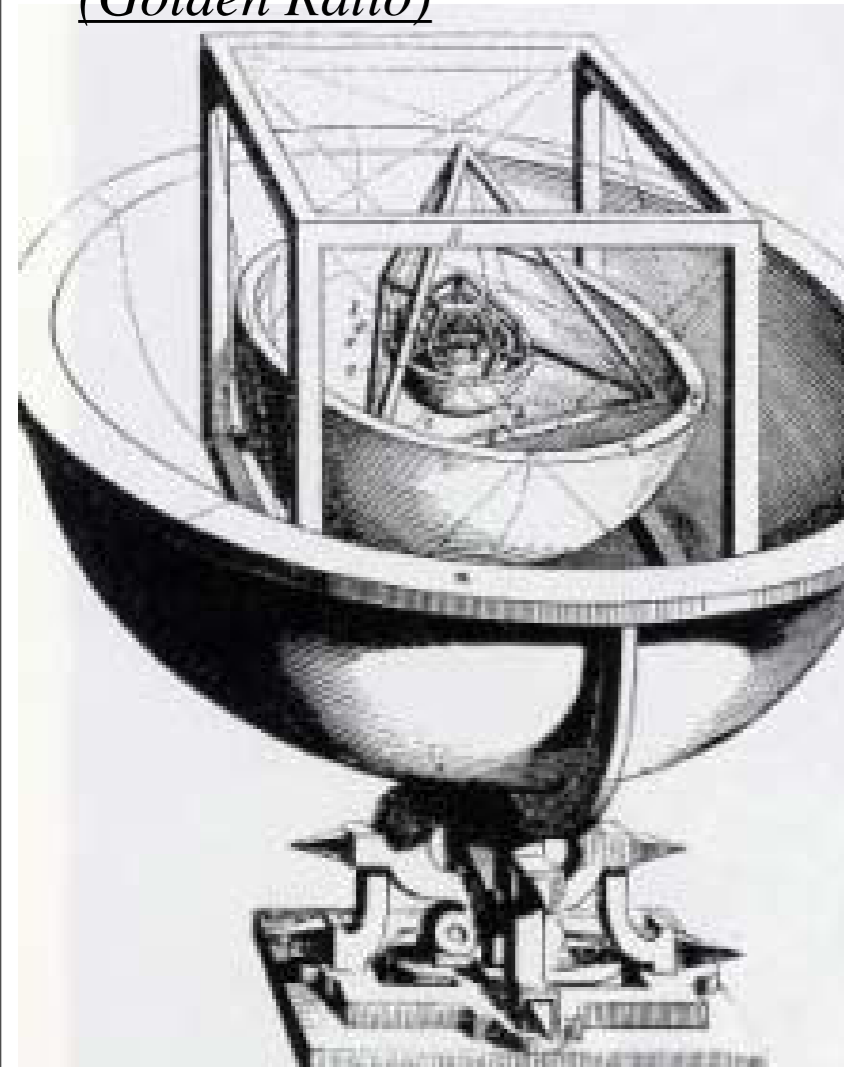

Platonische Körper  
Kepler



Sri Yantra



Islamische  
Kunst

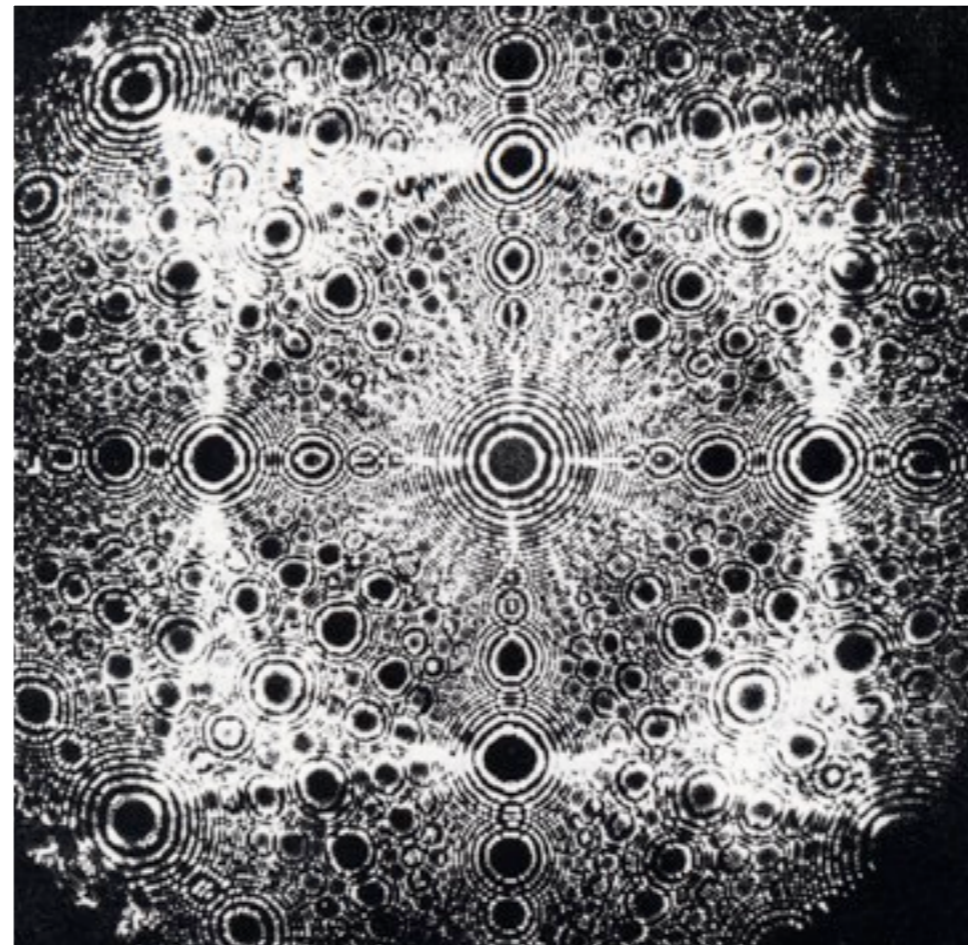





Interferenz  
Platin

DGEIM





**PhiGrid**



File Edit Convert Help











**Geometrie Data**

Script NGDC Map









 sym.

Visible  Link







Long/Lat  
 auto

Update  
 permanent

Navigation  
 Paint





Zoom 1.5  
 Scroll 10

Greenwich  
 Gizha  
 Center

Move  
 S37° 30' 55.3656"  
 E20° 20' 6.21691"  
 GRID/Lat/Long/Point  
 61455.816  
 25654.0523  
 0.41743896623226

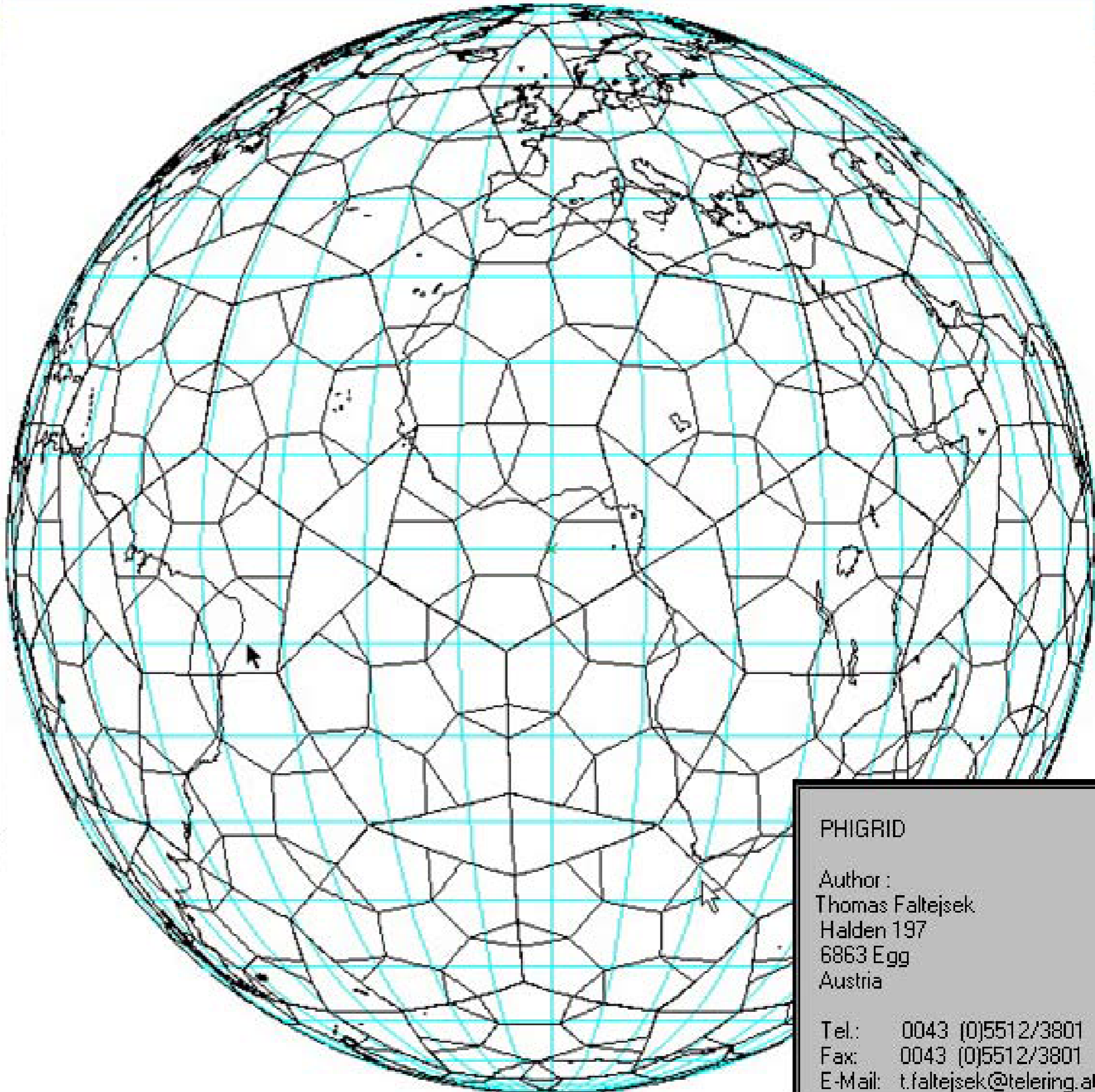
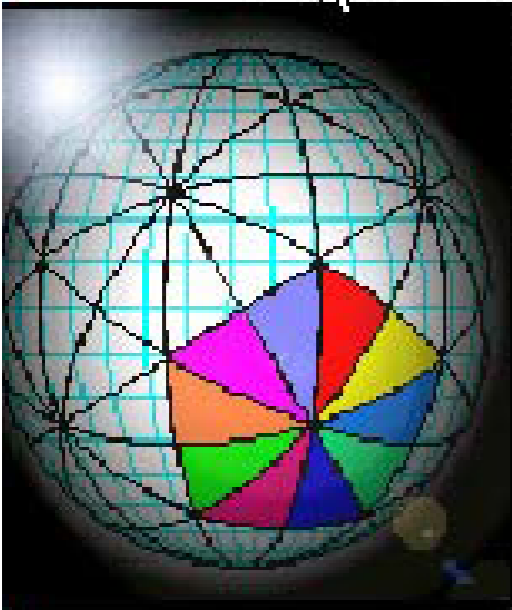

PHIGRID

Author:  
 Thomas Faltejsek  
 Halden 197  
 6863 Egg  
 Austria

Tel.: 0043 (0)5512/3801  
 Fax: 0043 (0)5512/3801  
 E-Mail: t.faltejsek@telering.at

**ORION STARGATE**

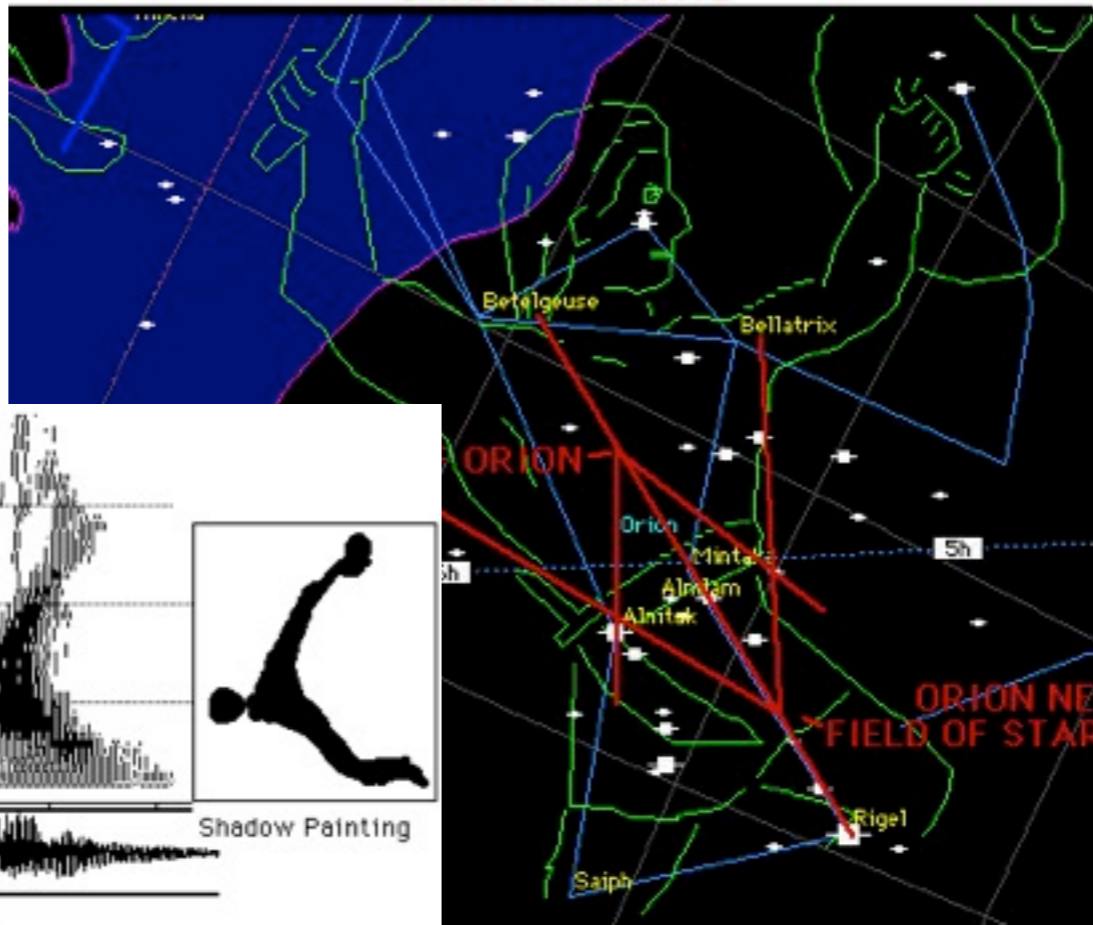
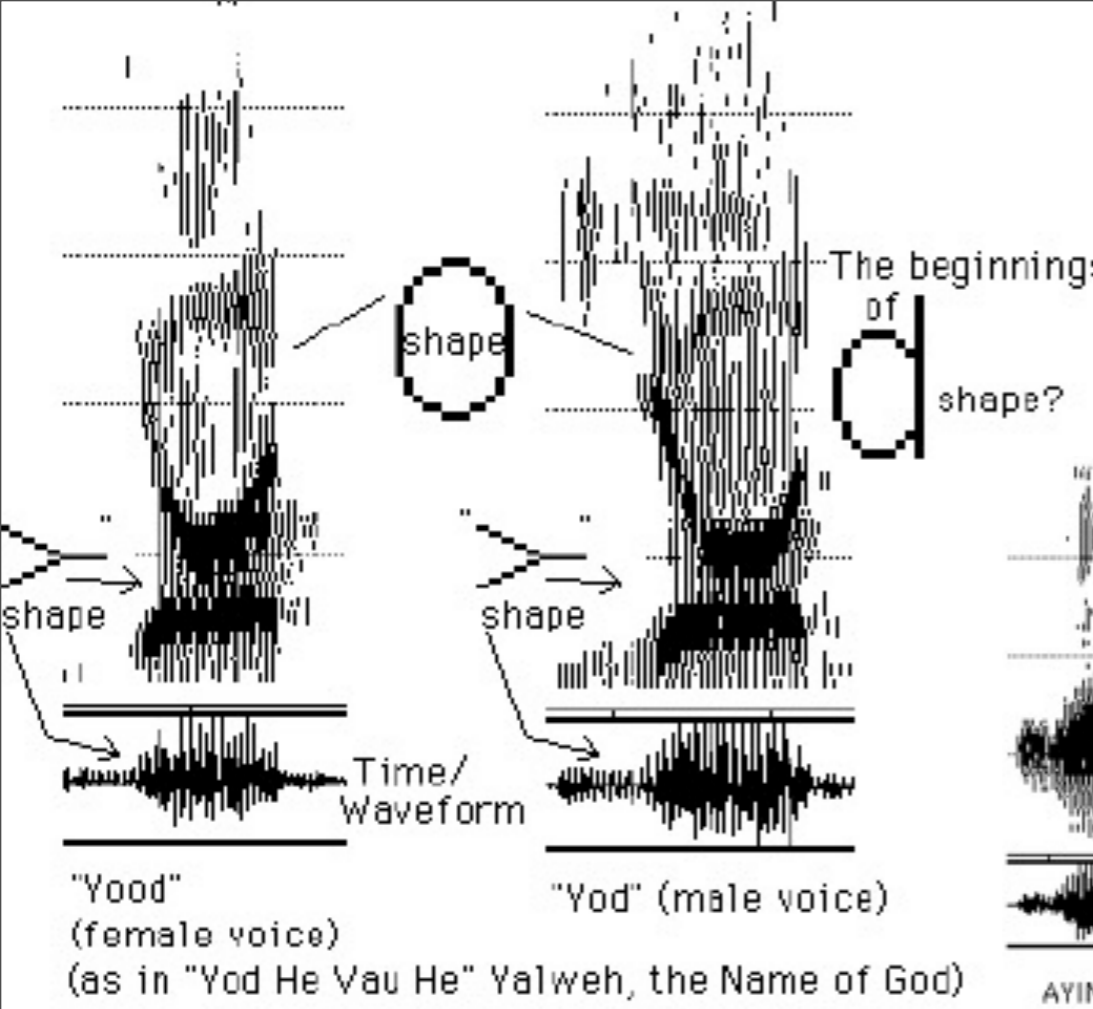

UPPER AND LOWER VORTEX LIGHT CONES CROSS TO IMPLOSION GALACTIC PORTAL...

HIGHER LIGHT WORLDS METATRONIC SPECTRA

(LENS EFFECT)

LOWER LIGHT WORLDS ORITRONIC SPECTRA

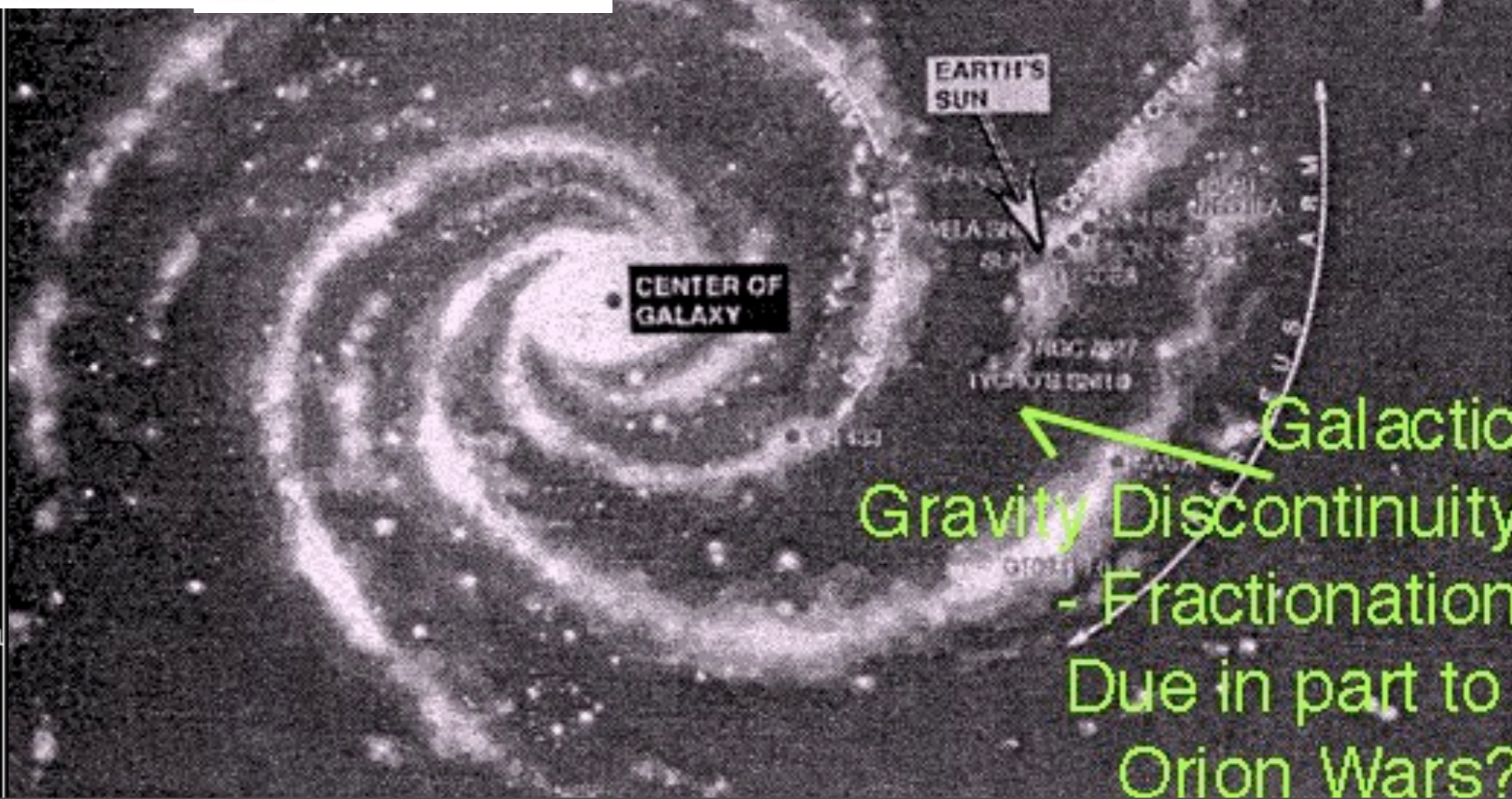
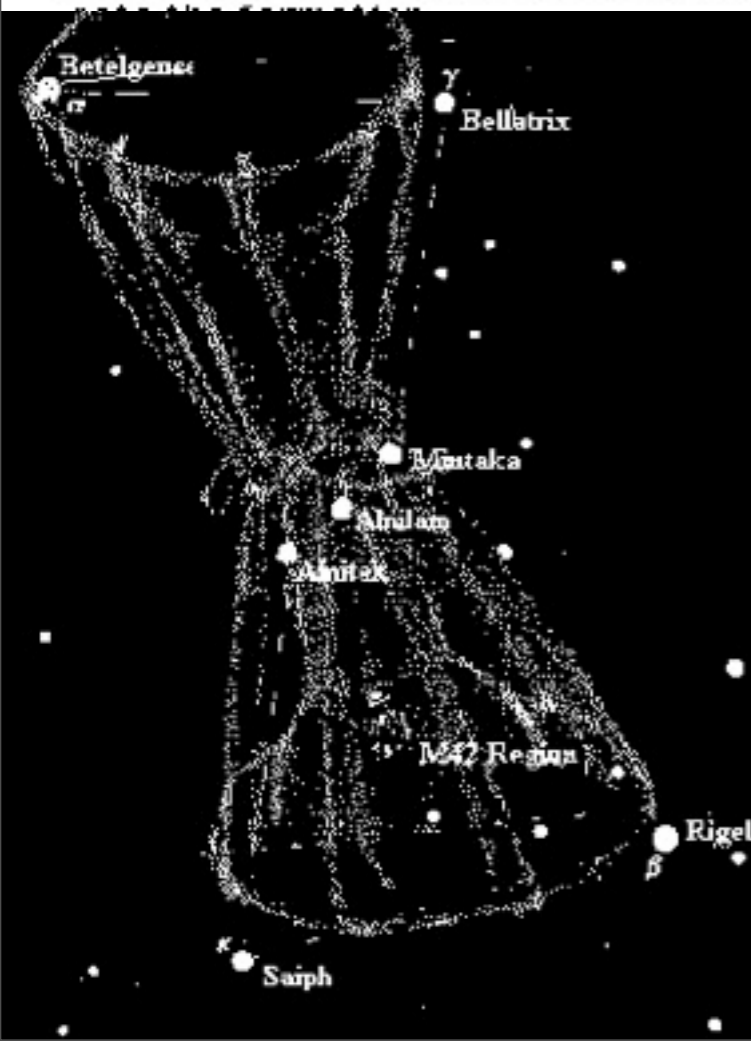
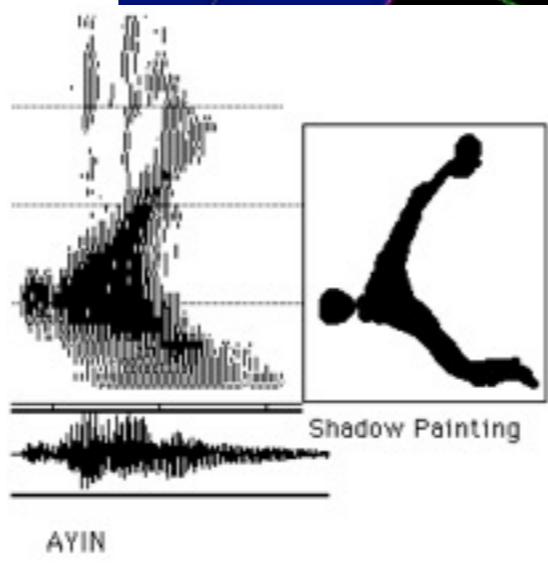

long-term temporal quality, and perhaps even the evolution of life itself, is somehow related to its alignment along the radial axis of the Galaxy.

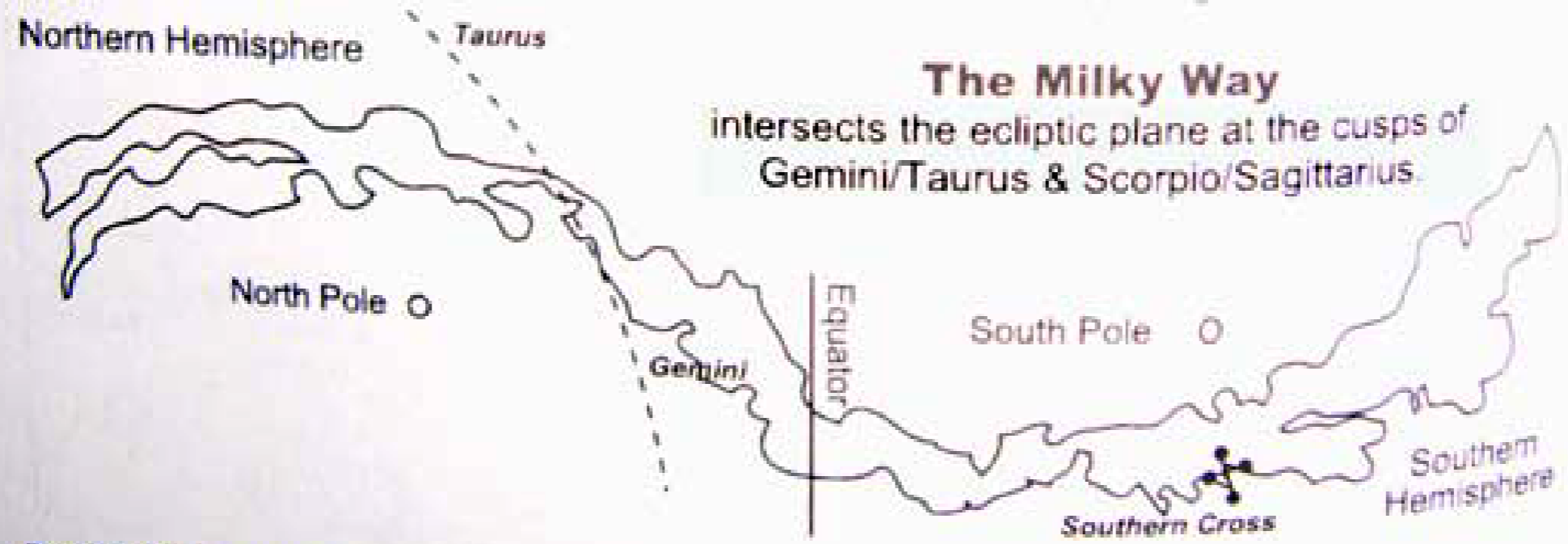
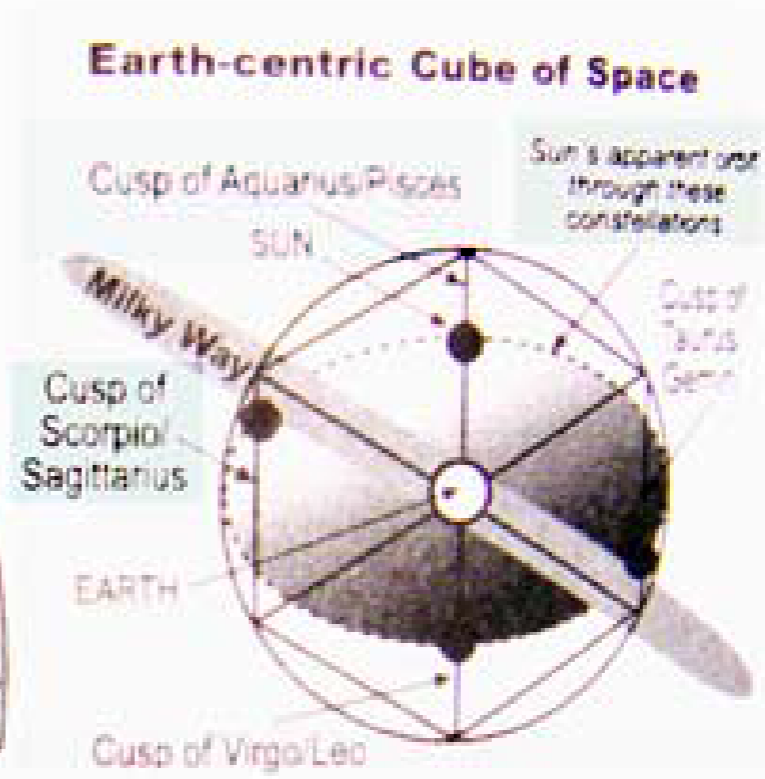
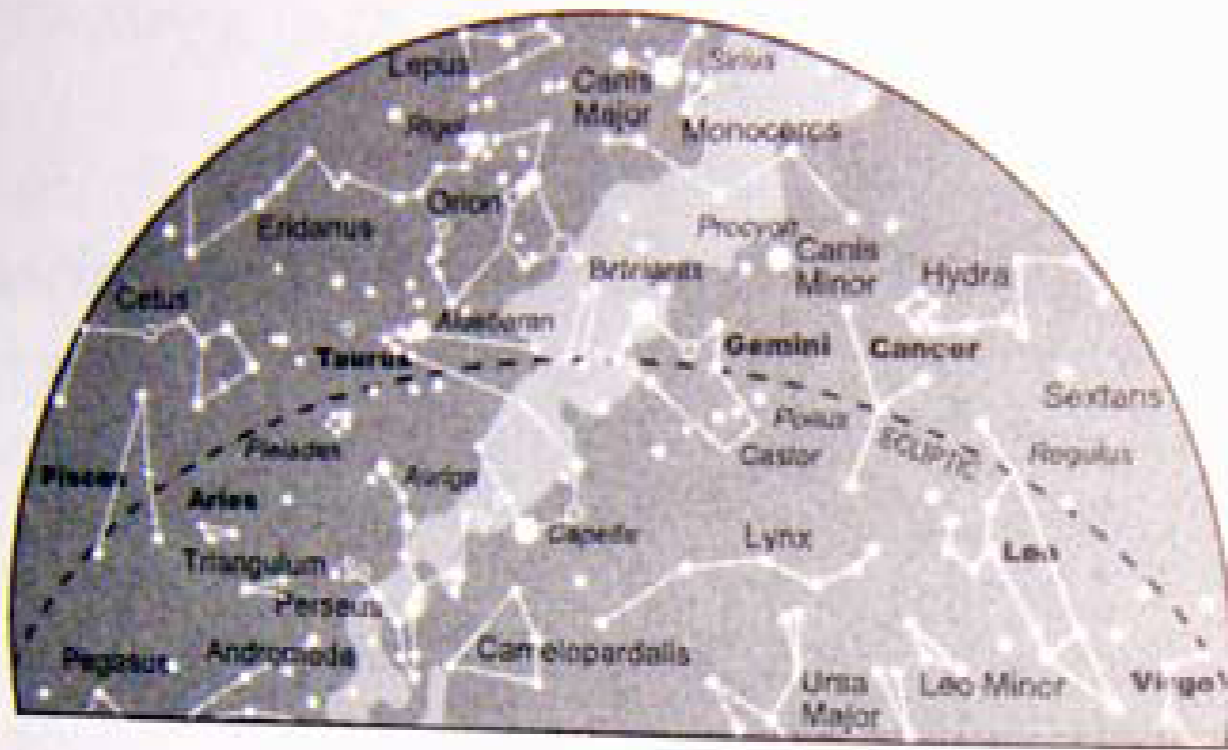
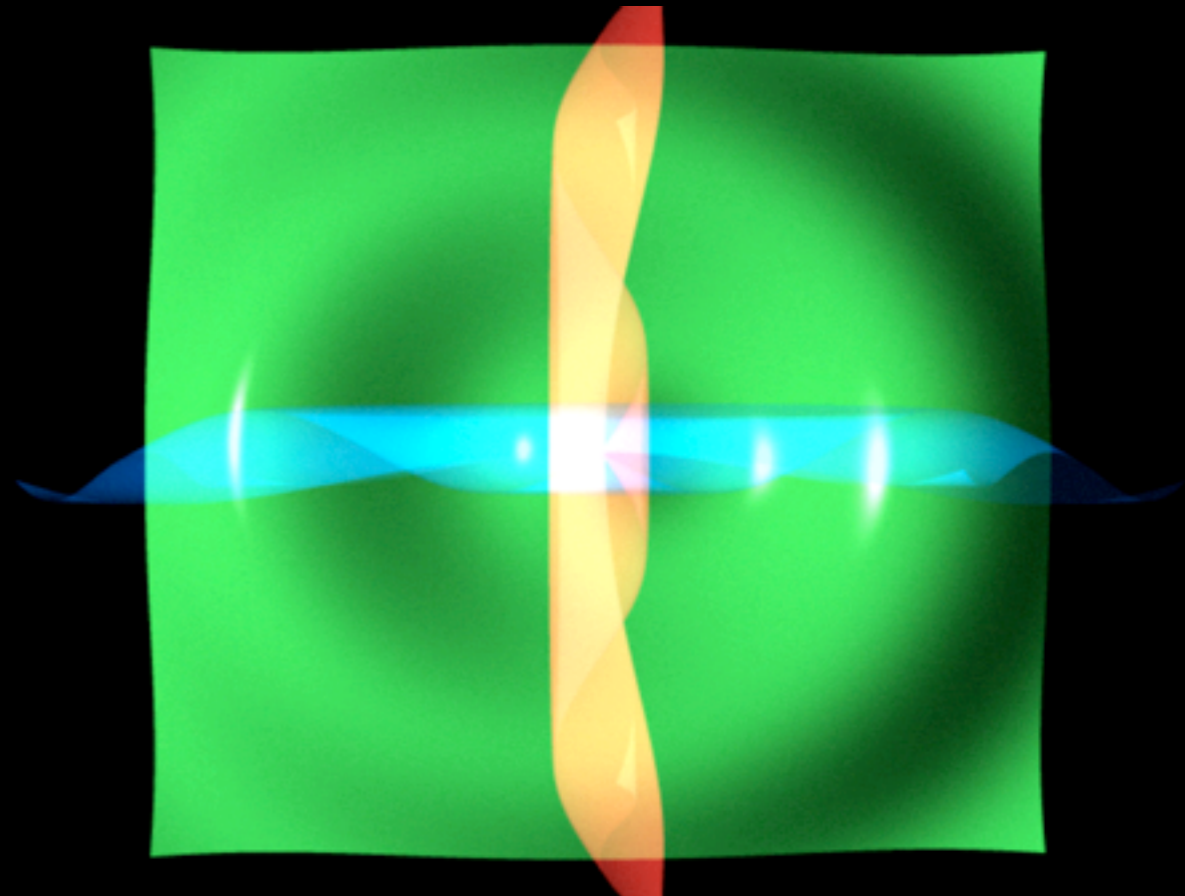
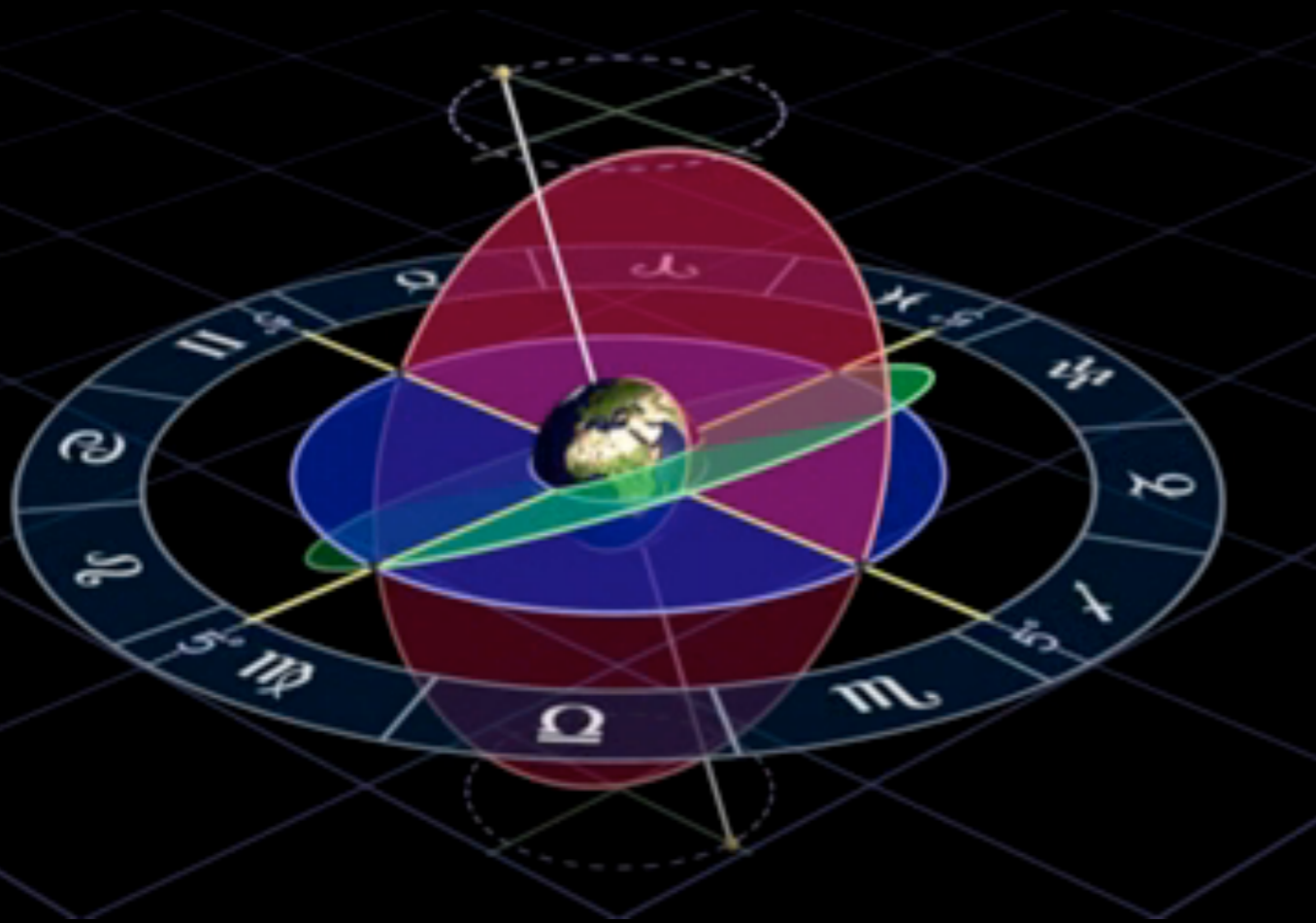

Figure 12.2. The alignment of the ecliptic, the solar cube of space and the galactic meridian. Note that the ecliptic crosses the galactic plane at the cusps of Gemini/Taurus and at the cusp of Scorpio/Sagittarius, as shown.







SPINNING DISK  
Side View

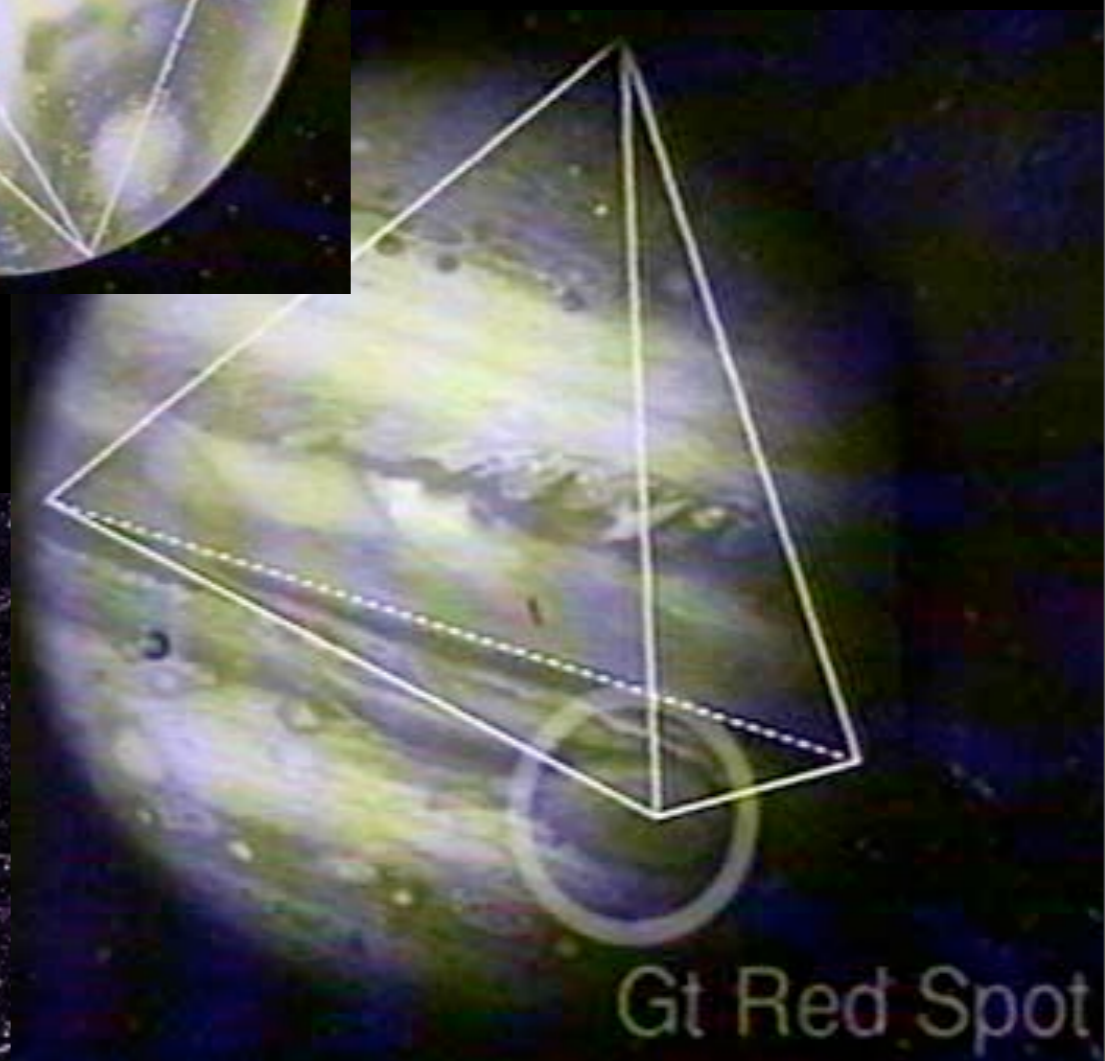
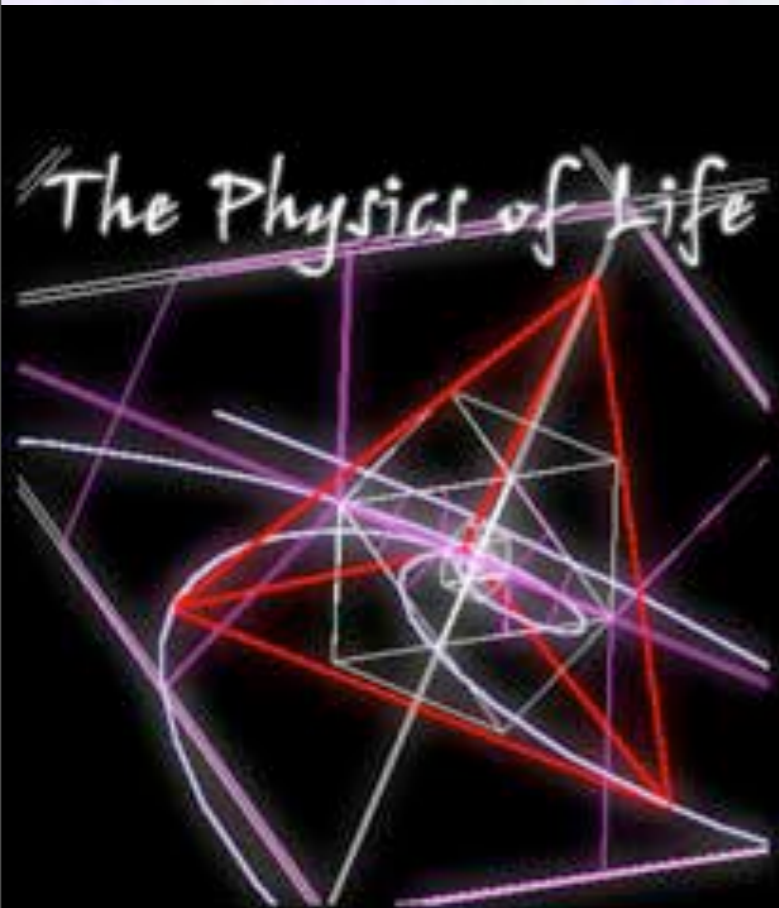
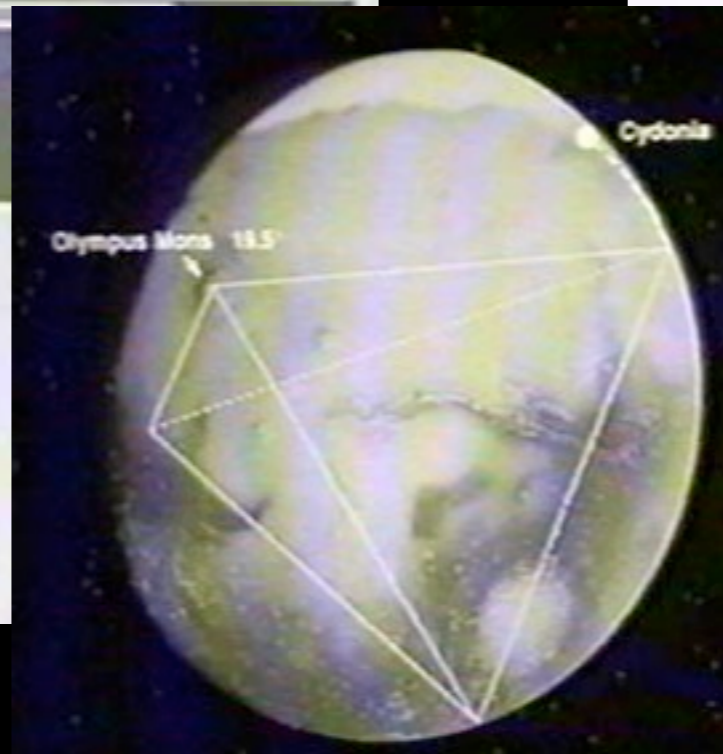
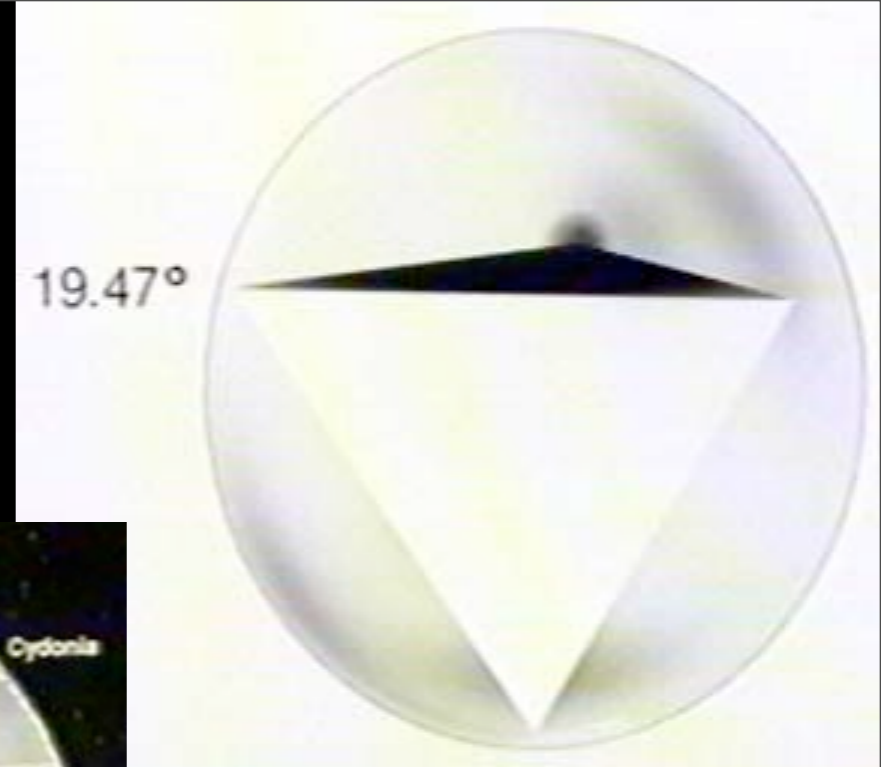

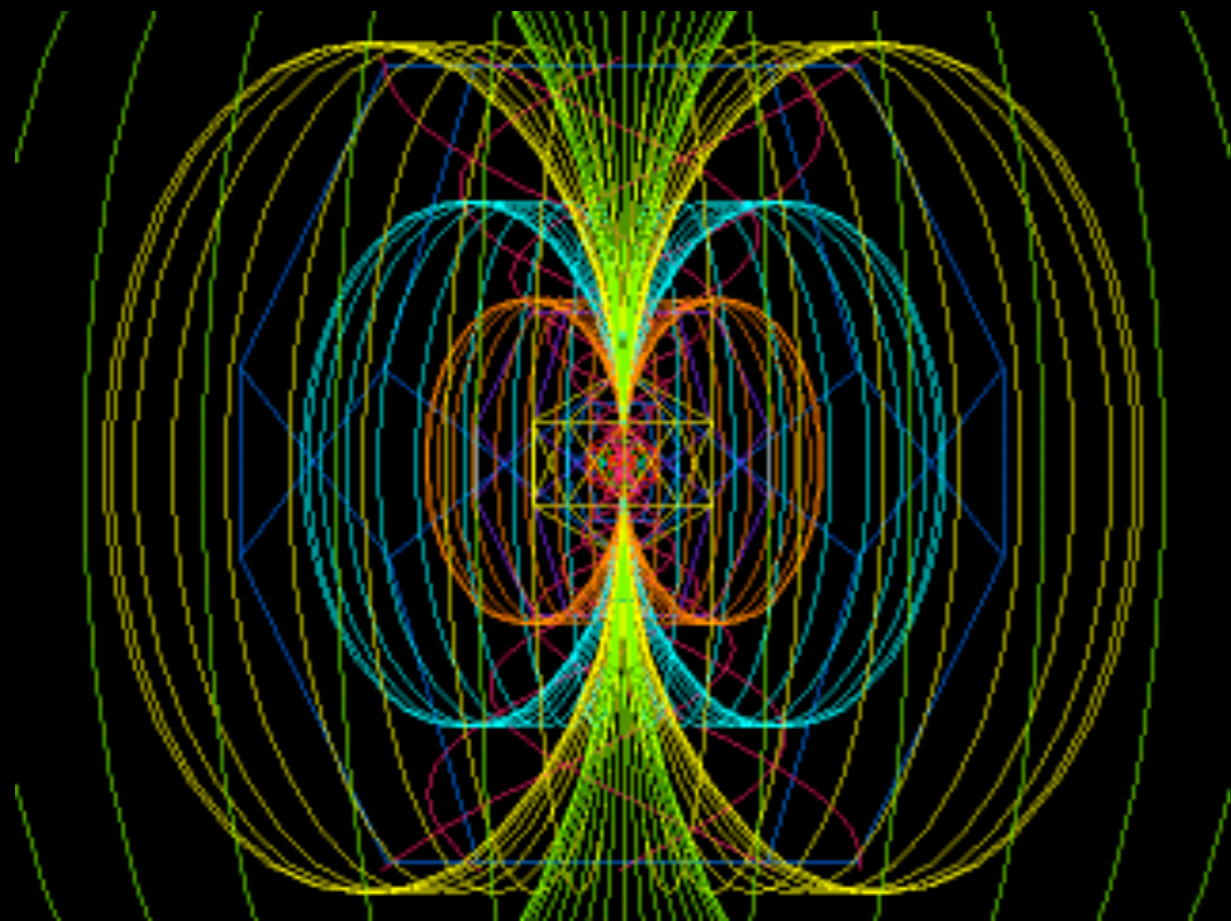

*Flag of Apha Draconis  
& Isreal : HEX  
Star Tetra /  
Shape of Alpha Draconis  
Star Ships & Star Ship Logo:  
Triangular..*

*Shape of  
HoneyComb  
Of a Hive Mind:  
HEX..*

*Individuation (Self Empowerment)  
Not a Priority*

*HEX Fixes.. Alpha Draconis  
Regards Genetic Change as  
Inherent Weakness..*



Golden Spiral. De Spiral kan naar binnen gericht zijn, soms naar buiten; de chart kan betrekking hebben op dagen, maar ook op jaren. De grafiek van de Dow Jones Industrial Index (*Illustratie 2*) over een zeer lange periode vormt hiervan een voorbeeld.

De Golden Ratio is ook te herkennen in de opbouw van cycli. De meest eenvoudige vorm is, een daling en een stijging, totaal 2 bewegingen. De meest eenvoudige samengestelde vorm is een daling bestaande uit drie bewegingen (twee omlaag, afgewisseld met een technisch herstel) en vijf omhoog (drie stijgingen, afgewisseld met een tweetal technische reacties) totaal acht, ofwel 3, 5, 8 uit de Fibonacci-reeks. Zo kunnen wij doorgaan. (*Illustratie 3*)

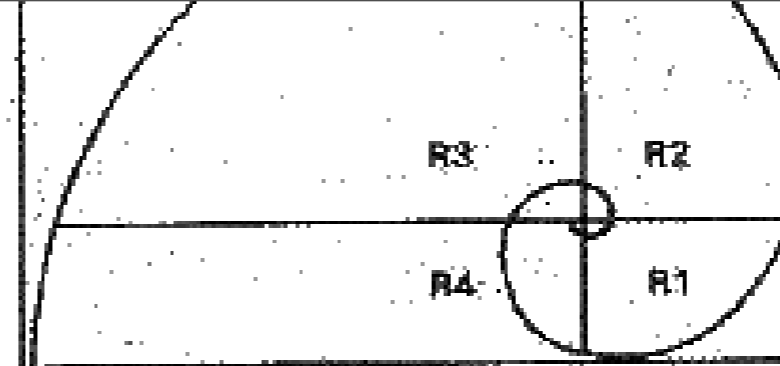

$$\frac{R2}{R1} = \frac{R3}{R2} = \frac{R4}{R3} = 1.618$$

De grote vraag is uiteraard welke de praktische waarde is van de Fibonacci-reeks voor de belegger. Geconstateerd moet worden dat vooral achteraf een opmerkelijk aantal herkenningspunten aanwezig blijkt. Op het moment dat deze zich voordoen blijken deze echter veel moeilijker te definiëren:

De theoretische Golden Ratio succesvol te werken is een flink ring nodig. Zelfs lieden die zich uur met het toepassen van de theorie en de Fibonacci-getal zighouden, blijken daarbij op menten de plank veelal mis te wel de Elliott Wave theorie en gekoppelde toepassing van de getallenreeks de laatste jaren doet menen wij dat ook voor ring geldt dat deze niet feil slechts gezien mag worden al vele hulpmiddelen waarvan zich kan bedienen. De Fibonacci-dingentabel kan een praktisch vormen. (*Illustratie 4*)

2

Also See  
[calendarresearch.com](http://calendarresearch.com)  
 The Spiral Calendar,  
 By Christopher Carolan

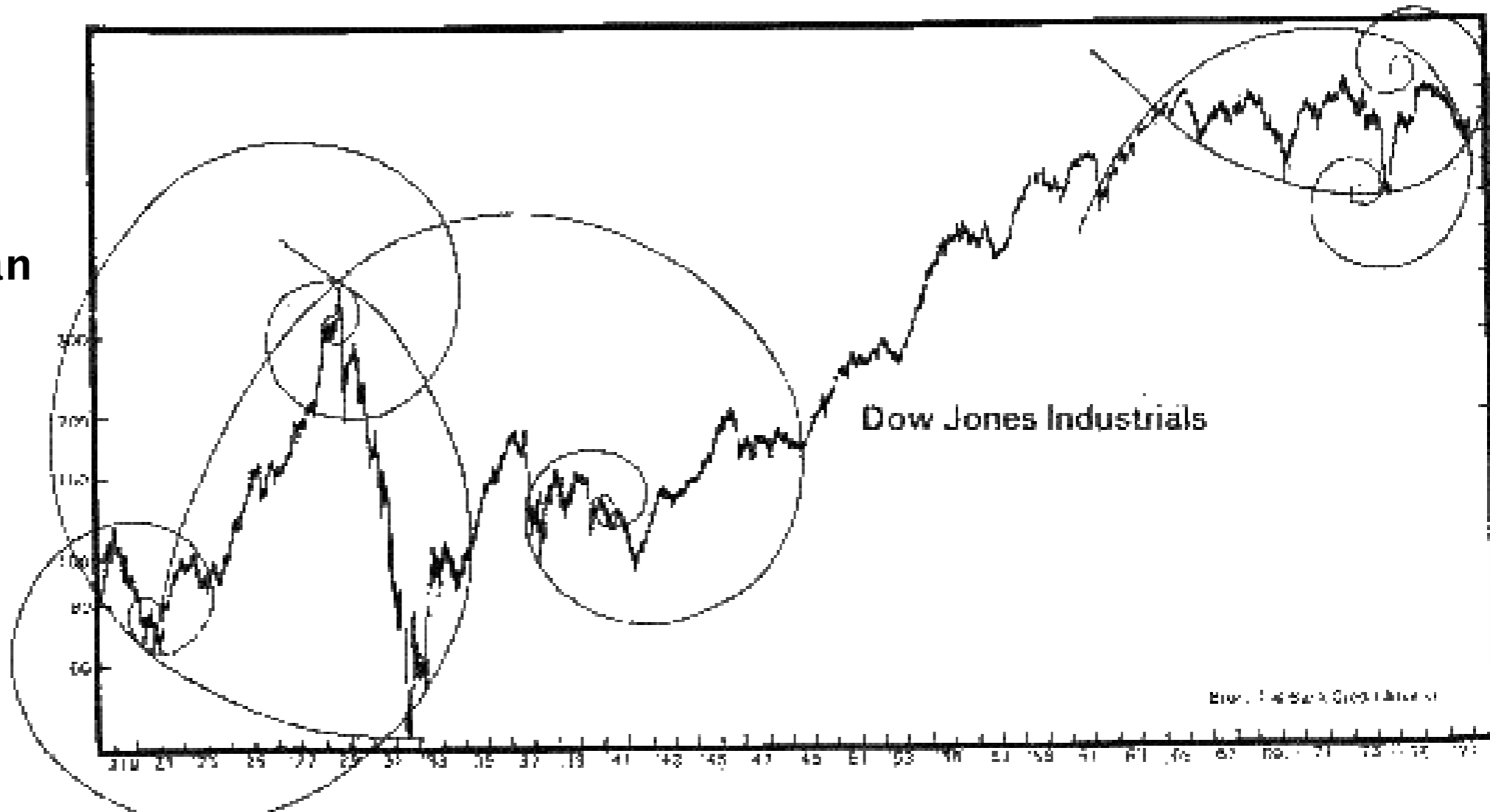
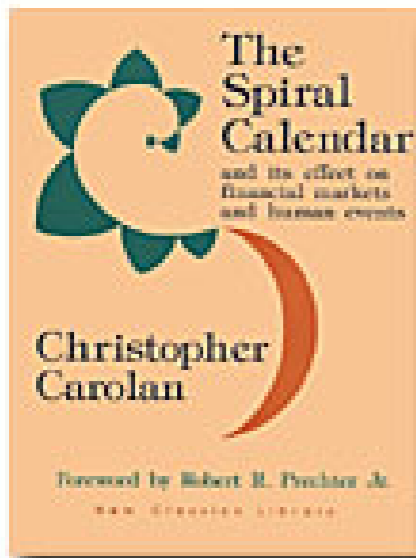

*“If it doesn’t rotate-it doesn’t MATTER, AND it’s not in TIME!”*

ROTATION (of charge)- defines MASS (inertia stored)

ROTATION (of mass) - defines TIME

Both must be Fractal to emerge from chaos (into  
consciousness / life)

All time (memory= charge pattern density)  
is present where waves of charge can converge - with  
infinite compression (fractal).

## The symmetry of perfected phase conjugation (caduceus)- electrical self organization -IS:

- **the reason any dielectric is biologic and ALIVE!** defining living material for architecture (what capacitor can HELP a seed germinate)
- the REASON any enzyme is ALIVE- (the DNA recursive braid- why heat kills a live enzyme -structurally - de-organizing electrical recursion ).
- the reason any bio-ceramic material can reduce electrosmog or heal or nourish biology.
- Bio ceramic= phase conjugate dielectric. Mesenchymal stem cells and bioceramics: strategies to regenerate the skeleton. skeletal regeneration by bioceramics - success predicted by phase conjugation success-

- the essential mechanism behind all energy / electrical healing technologies. (with power spectra examples-below)..
- the essential mechanism for the 'still point' in sacral cranial work, healing crisis in psychological work , also the - 'collapse process' in counseling work...

: charge compression HEALS by sorting



## Harmonic Inclusiveness – Fractally Perfected CHARGE COMPRESSION:

How Medical Statistics Measure Heart (HRV) to Predict Predict Resistance to virtually ALL CHRONIC DISEASE.. (Compassion = Compression?)

(ref: Dr Dardik – ‘Making Waves’ see: [soulinvitation.com/holarchy](http://soulinvitation.com/holarchy) )

- = Genetic Diversity
- = Access to Fractality (definition of grounding for psychologists & electricians)
- = Fusion/Implosion
- = Charge Communion
- = Turning on DNA Radio – the aura production called sainthood / enlightenment – which Korotkov measured example in GDV during bliss / peak experience.
- = Access to the –collective unconscious, synchronicity, san-graal DNA piezoelectric ring-grail.
- = Ability to Respond/ responsibility – self empowerment
- = CHARGE DISTRIBUTION EFFICIENCY
- = How LIFE POTENTIAL is MEASURED in liquids as RE-DOX Potential.
- = How COHERENCE in biologies field effect – the KA (thar,tholic-boat to underworld) prepares to survive death in what compresses out of DNA thru light speed.

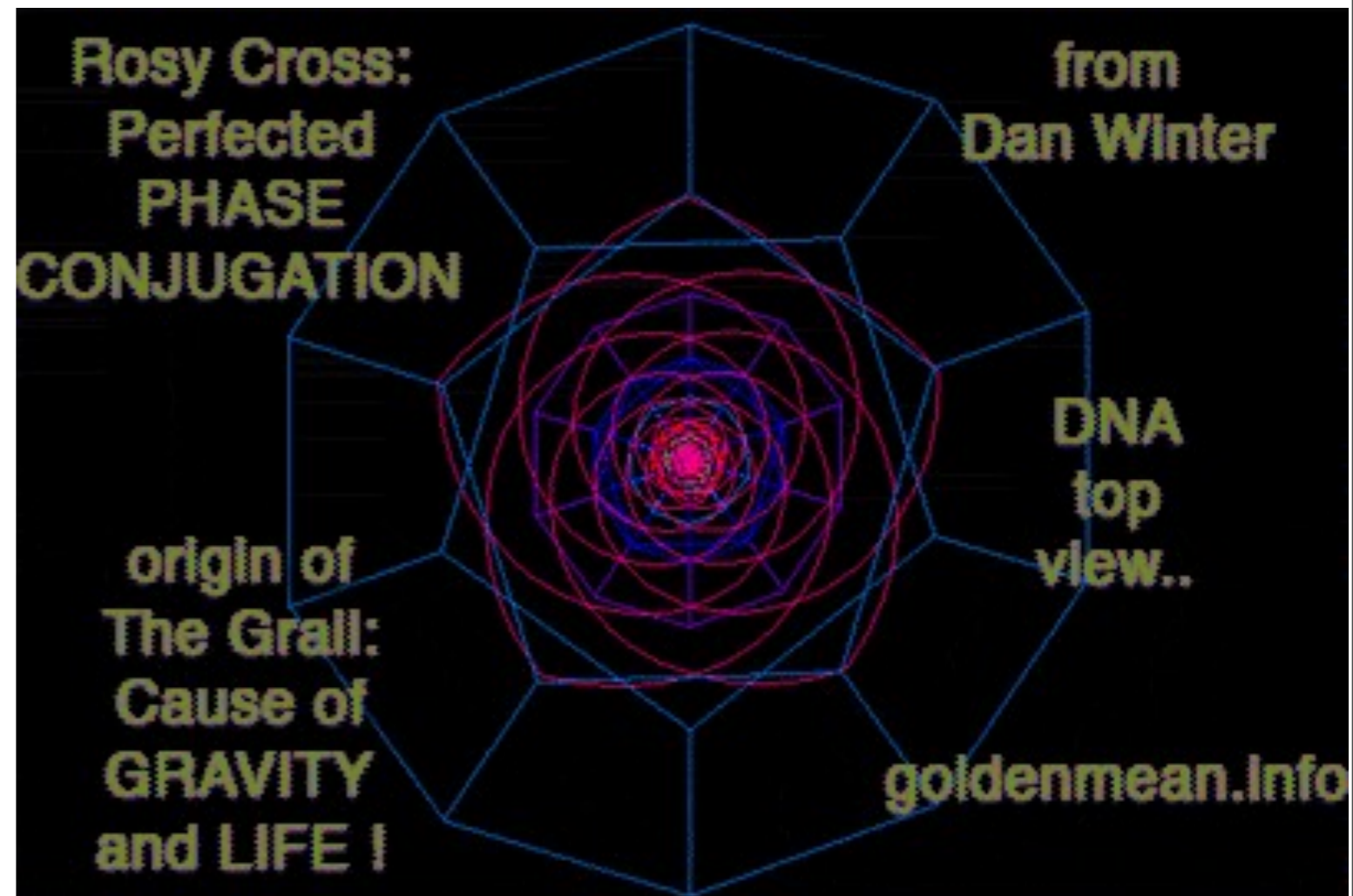

## PHASE CONJUGATION (Implosion perfected by Golden Ratio ) is the essential mechanism of:

- – how gravity is made, (for example power spectra of the Hutchinson Device spark would show damped cascade producing self similarity) – Hendershot device...
- – how DNA radio works (charge communion, the collective unconscious, and the soul work by coherent communication thru superluminal velocity modes nested by PHI),
- – the real physics of the origin of the HOLY GRAIL– DaVinci Code – why S.France and Washington DC grid sites are all PENT etc..
- – how awareness and bliss develop electrically around the brain as an imploding charge field–  
[soulinvitation.com/clinicalintro](http://soulinvitation.com/clinicalintro)
- – how the charge propagation phase path from facet to molecular to atomic to nuclear symmetry make the PHASE CONJUGATE MIRROR .. + the fire crystal of Atlantis (Tuoi stone)

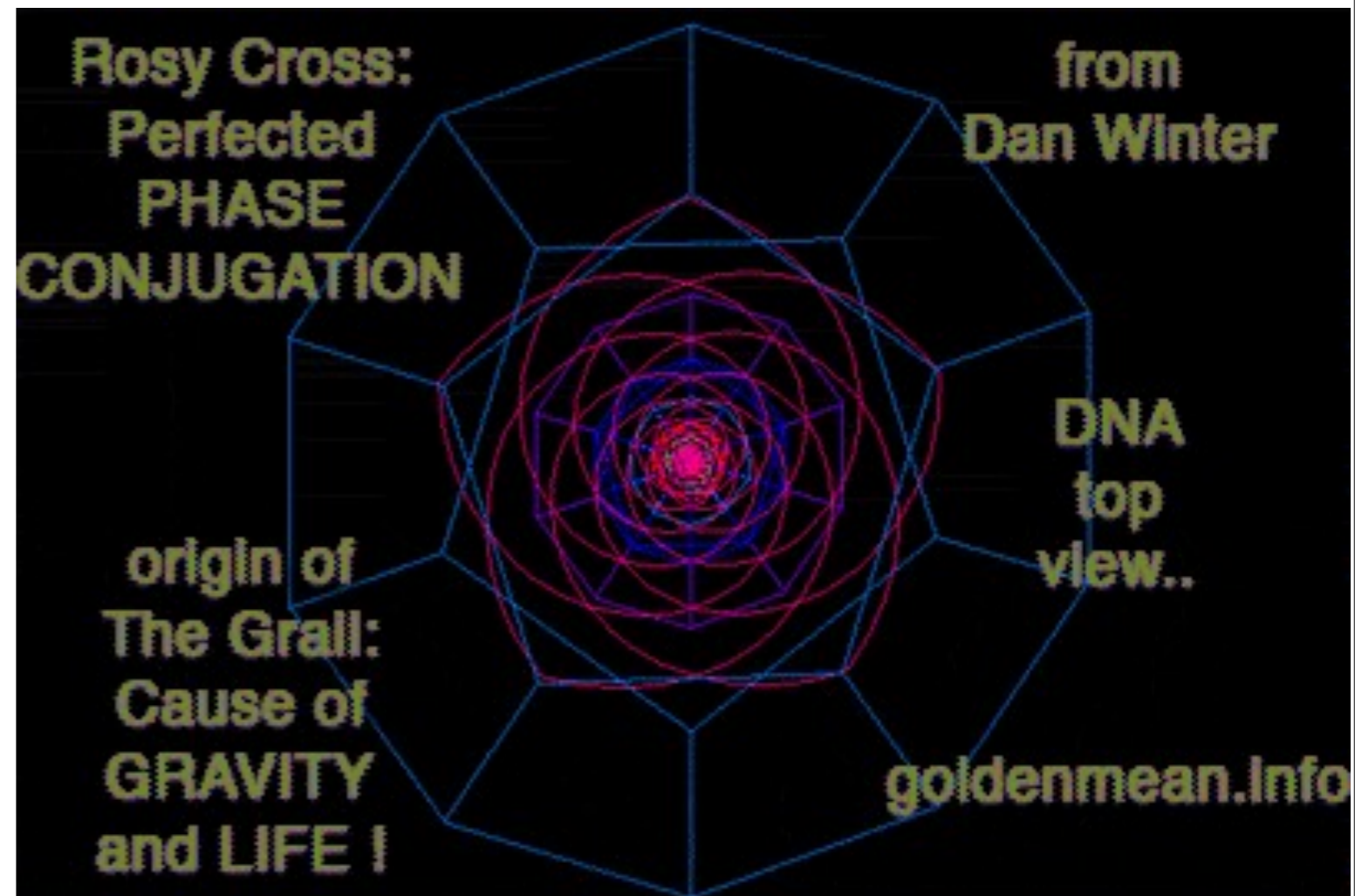



# Phase Conjugate Dielectric:

- **Physics of HOLY GRAIL + CAUSE of GRAVITY** (infinite collapse / produces magnetic monopole..)
- **Rosy Cross= Perfect PHASE CONJUGATION =IMPLOSION-** the only fusion symmetry possible where infinite phase velocity modes converge CONstructively.. (converts charge compression to acceleration>makes gravity)..
- This is the exact symmetry (dodeca stellation by Golden Ratio perfected recursion)-> :
- ->**Einstein / Poincare used to model charge symmetry of gravity / infinite compression**
- ->**identifying optical phase conjugation** (time reversal , aberration self correction etc..)
- ->of Palladium / dodec - key to cold fusion
- ->charge path thru phase conjugate dielectrics(ex:barium titanite)key to access to voltage from gravity
- ->of the **top and side view and wratchet of DNA** (charge communion by phase conjugation /mechanism of soul ) (all living proteins are 5 sided/Phi for this reason)
- ->water molecules use (clathrate cage/dodec) to become part of all LIFE (fractal charge distribution)
- ->of **monoatomic (implosive ) Gold atoms** ("Manna, ORMES, the 'Spice'..
- ->identifying the CHARGE PATH (breath of life-

charge communion) **identifying**

**BIOLOGIC MATERIAL for ARCHITECTURE..**  
(only possible defineable meaning for a commercial term 'organic')

- ->identifying the **(Phi / caduceus) harmonic analysis of EEG in Ecstasy, life force in water, harmonic inclusive EKG predicting all disease survival, harmonic content (PHllotaxes)of all life.** .(charge attracting self organization)
- ->the **JITTERBUG** (cube-octa down to icosahedron)  
- presented as mechanism for molecular superconductivity at International Conference on superconductivity, Buffalo, NY by Jim Sawyer, 6 Dimension Design.

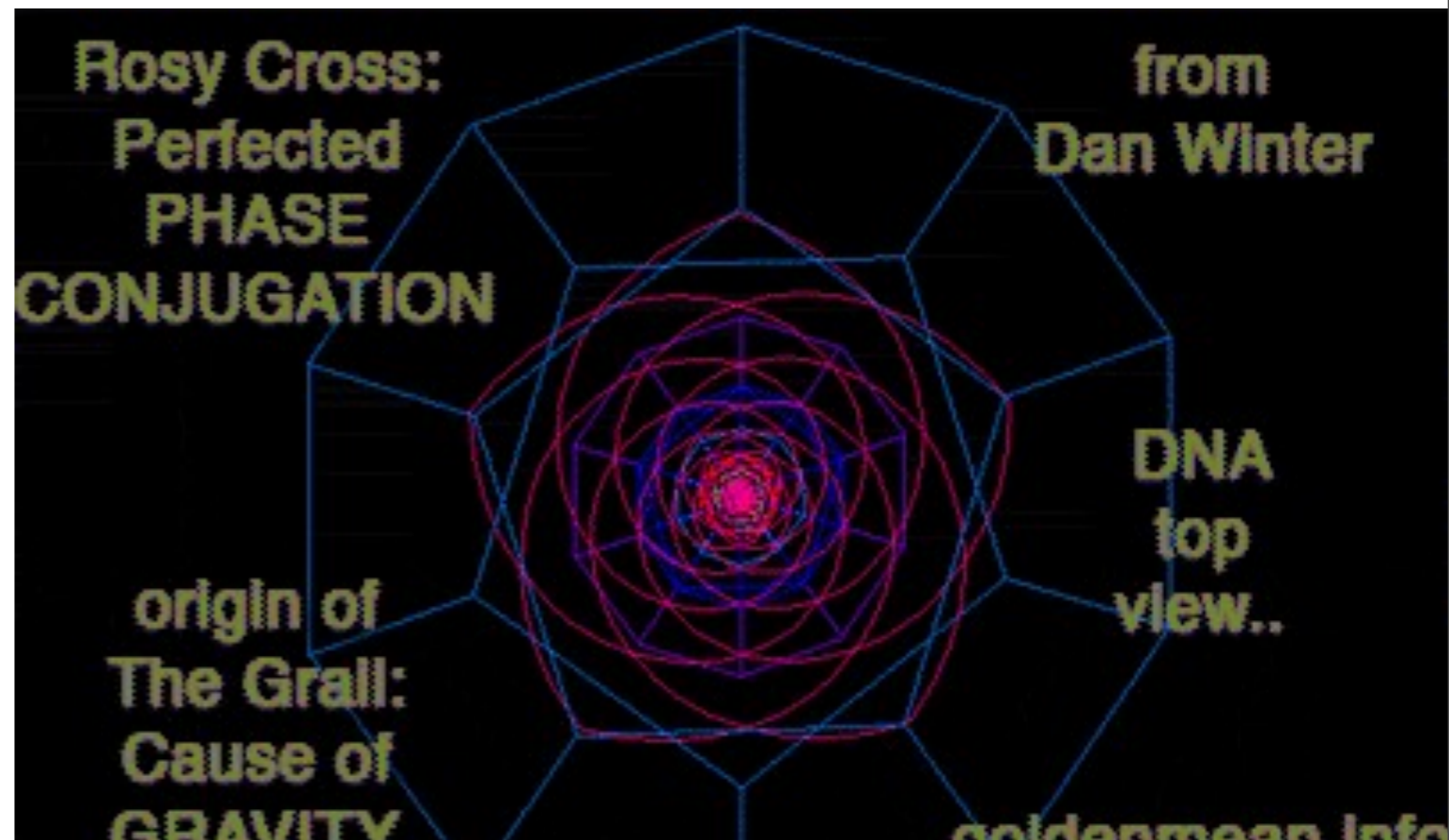

*Why Mind Inhabits Phire.*

*Phi*

*h*

*i*

*Recursion*

*Induced*

*Charge*

*Acceleration /*

*Implosion*

*Solution*

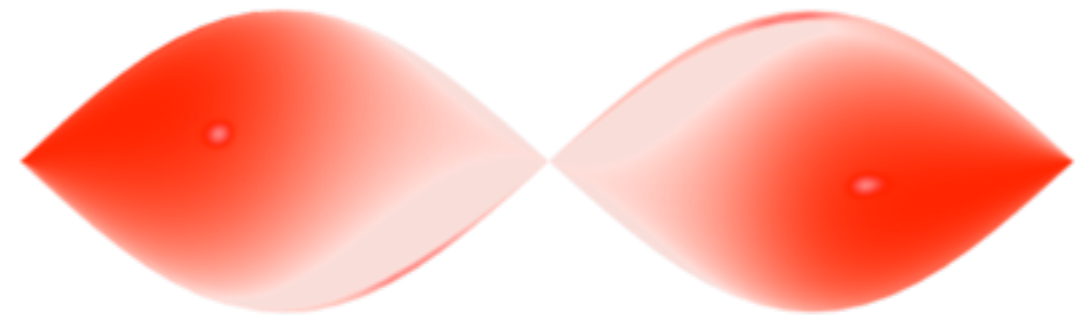

Implosion-  
First: How it Works.

Second: How to Use it.

# PhiRICAIS

(Musical Recipe to Implosion)  
is THE Solution to:

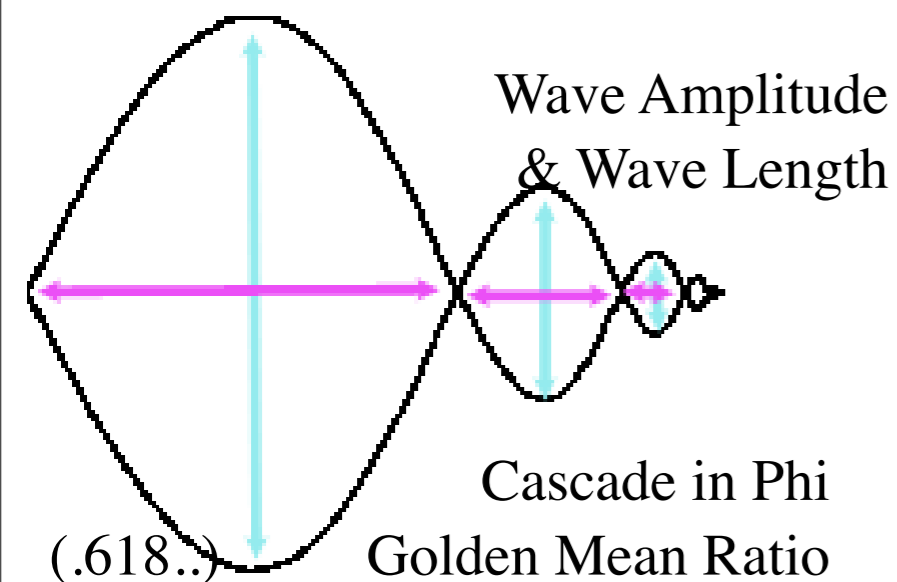

*How PhiRICAIS (Implosion)  
is revealed by Spectrum Analysis*

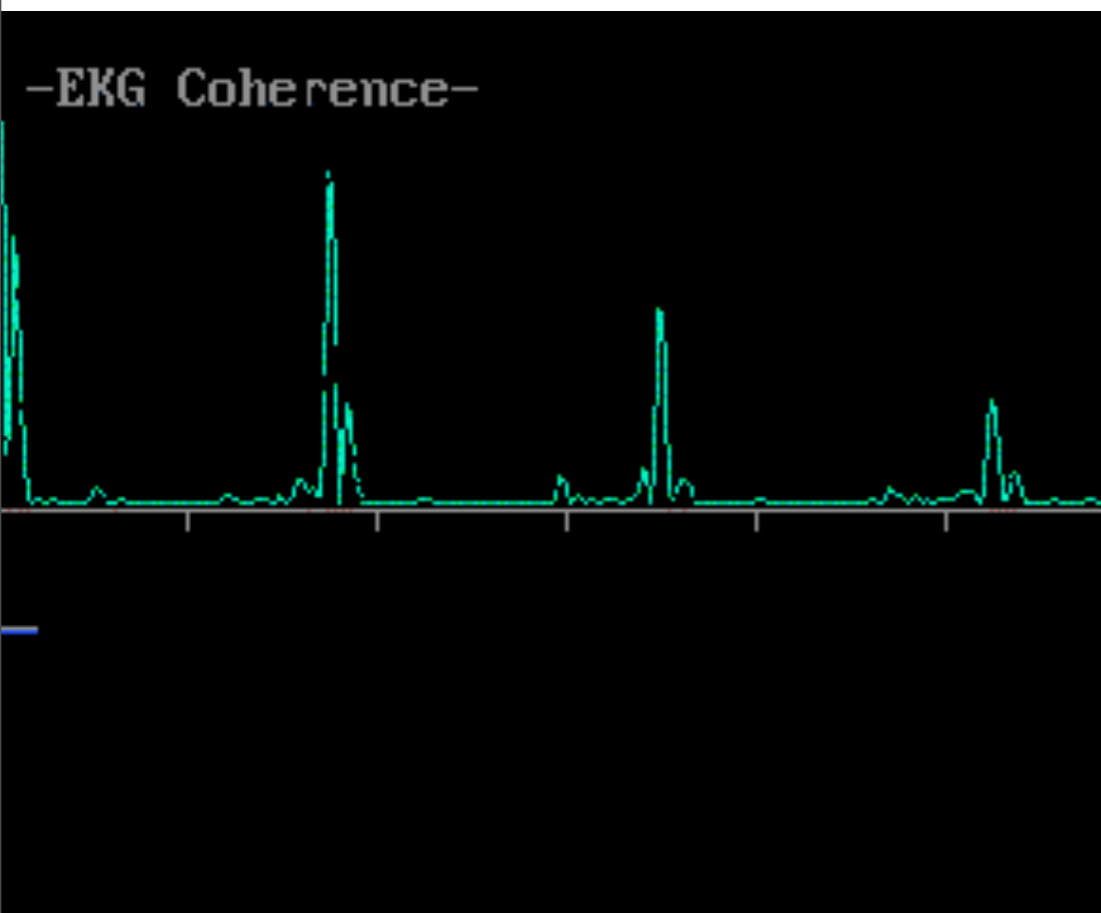

1. Infinite Non-Destructive Collapse
2. Infinite Compression / Perfect Acceleration
3. Perfect Damping / Phase Conjugation (optics etc)
4. Hydrodynamic Implosion (Ultimate Sorting)
5. Non Linear Energy (Voltage from Gravity)
6. Charge Acceleration thru C Light Speed (Gravity)
7. Measuring ATTENTION/ Bliss / Euphoria in EEG
8. Audio Tone Induction of EEG Transcendence
9. Measuring EKG Heart Openness / Compassion
10. Self Organization from Chaos/Artificial Intelligence
11. Electrically Defining & Measuring LIFE FORCE
12. Pure Geometric Origin of Alphabets (symbol=to embed)

..and the Grail

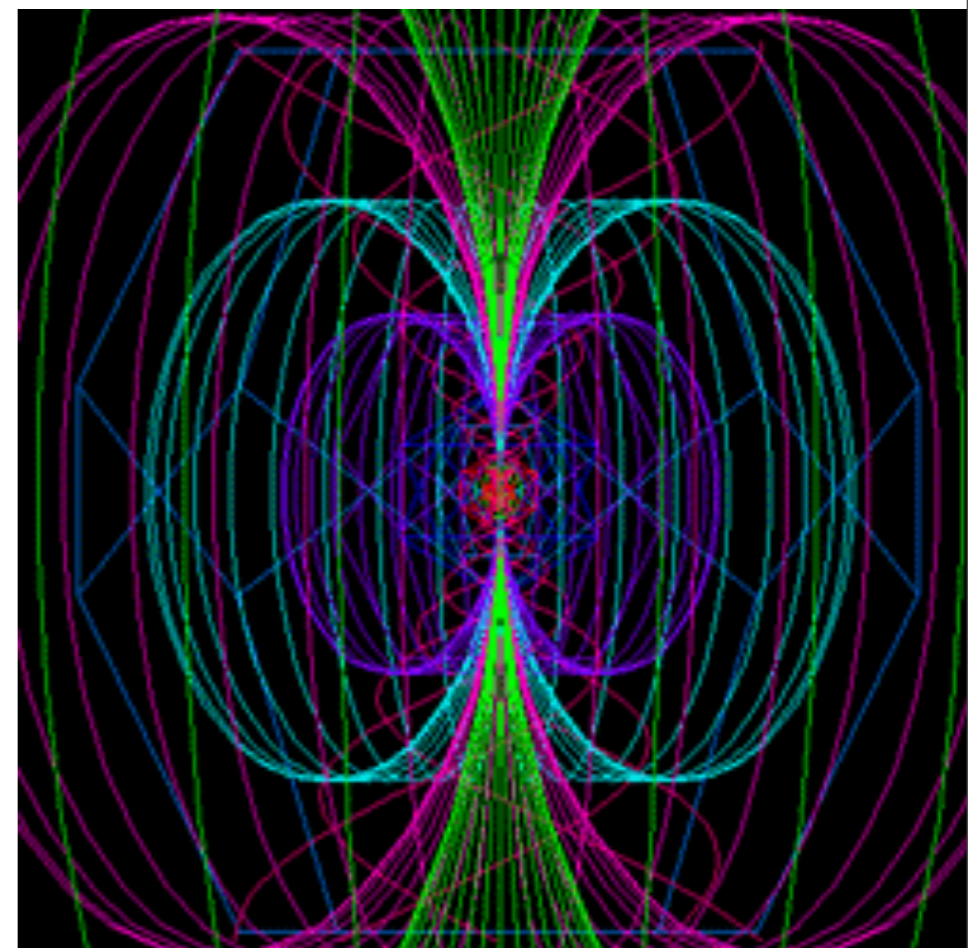

Thru this  
IMPLOSION  
Or ZERO  
Point  
ONLY  
The  
SHAREABLE  
Or ABLE TO  
GET IN  
PHASE  
WAVES  
SURVIVE..

How IMPLOSION /  
FUSION .. SORTS...



Implosion Zero Point-  
Pine Cone PHIRE of life



Surviving this Charge Compression  
In DNA is the Key  
to Successful Dying

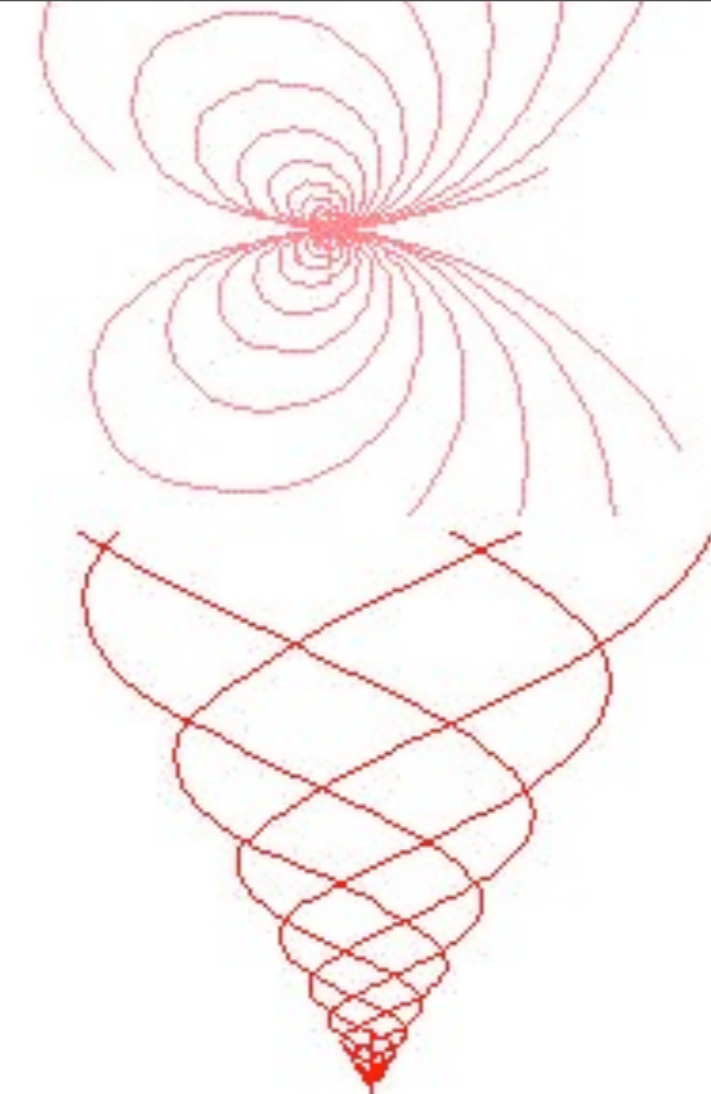
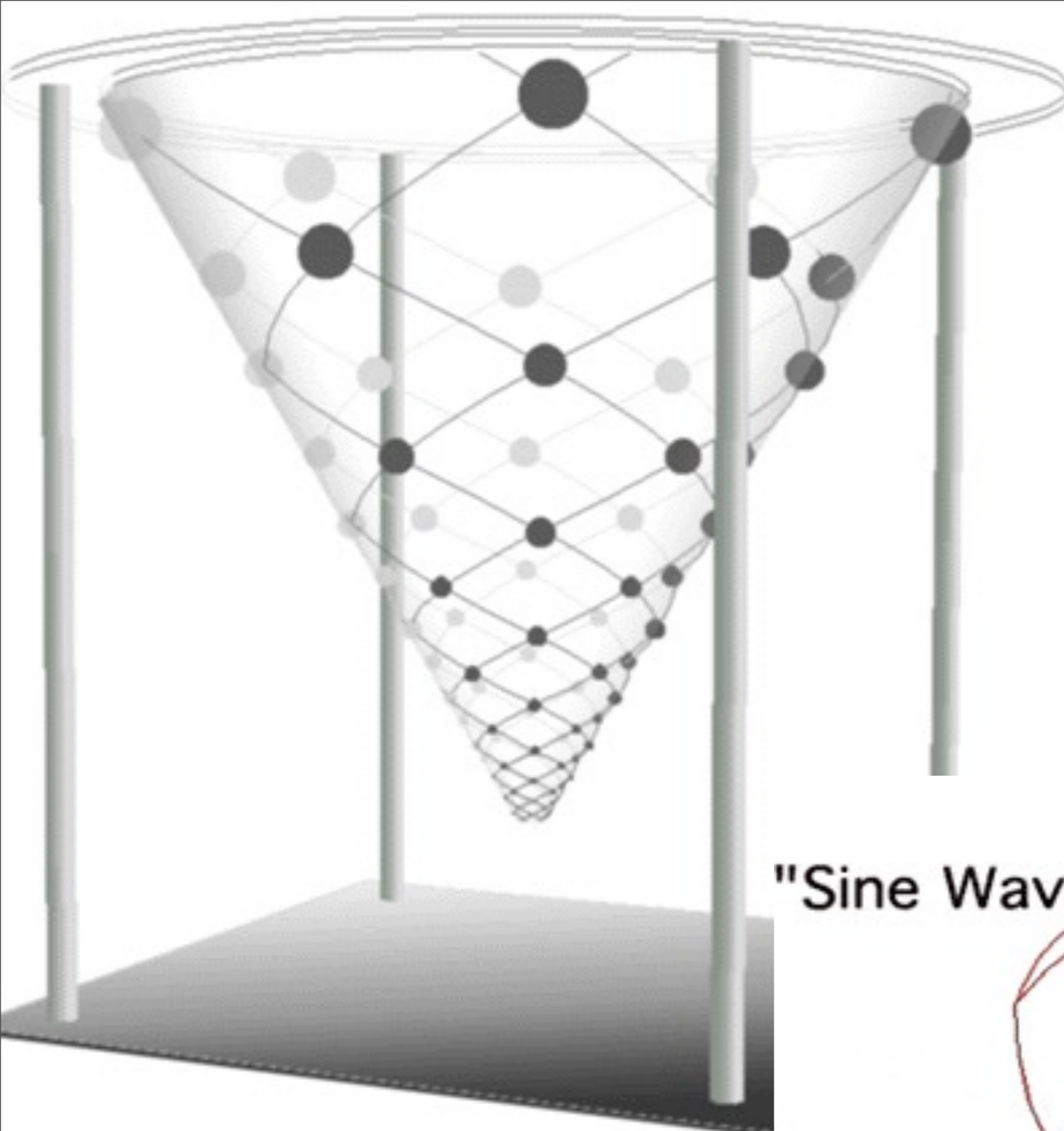

"Sine Waves"



GOLDEN MEAN RATIO

PERMITS ADDING  
AND  
MULTIPLYING  
OF WAVES

**Implosion Paths for 'Charge' seen in the 'Projective Geometry'  
Around a pine cone - adapted from "Vortex of Life"  
by Lawrence Edwards..**

**The principle of perfect braiding, or 'pining away' is the steering  
of flow to a universal meeting or fusion or implosion point.**

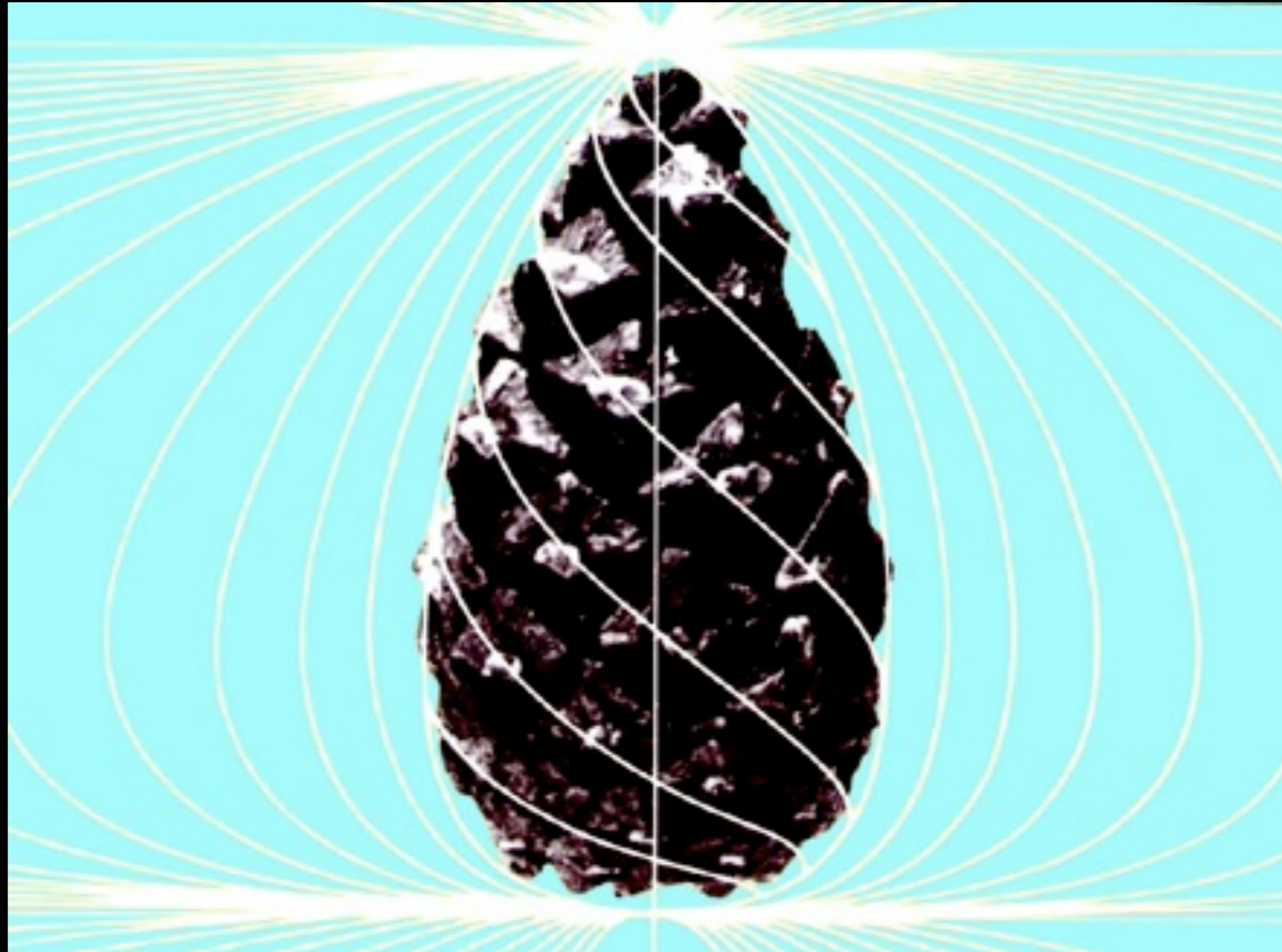

Edwards-Fields of Form  
Pine Cone

This is the  
source of the  
DC Voltage  
measureable  
in an egg  
or pine cone  
which  
quantifies  
life force.  
(most eggs  
generate  
2-10 mv  
due to implosion)

**From that 'point of perfect meeting' all waves EMERGE SORTED..**

**Only 'shareable' waves which can agree and get in phase survive..**

**This illustrates how implosion becomes the principle of sorting for waves in general.**

**In physics - this principle is called 'fusion' and 'phase conjugation'.**

In Vortex Implosion Design: Power Out derives from Charge Acceleration thru C (light speed)

- The water is piezoelectrically 'doped'.

Port-U-Grail

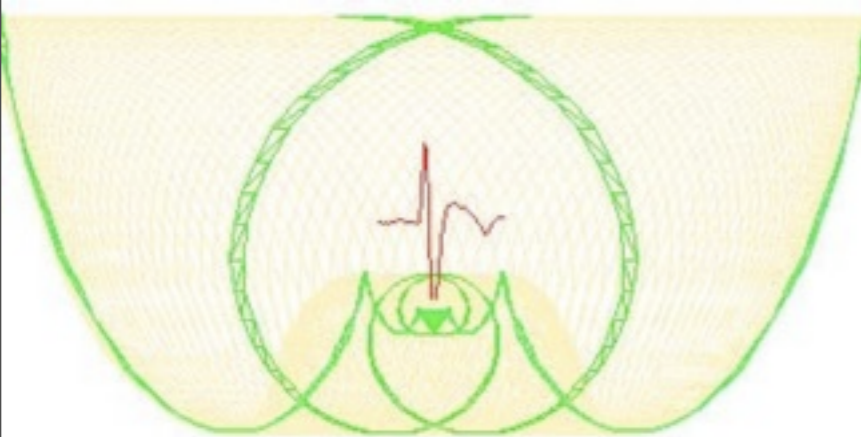
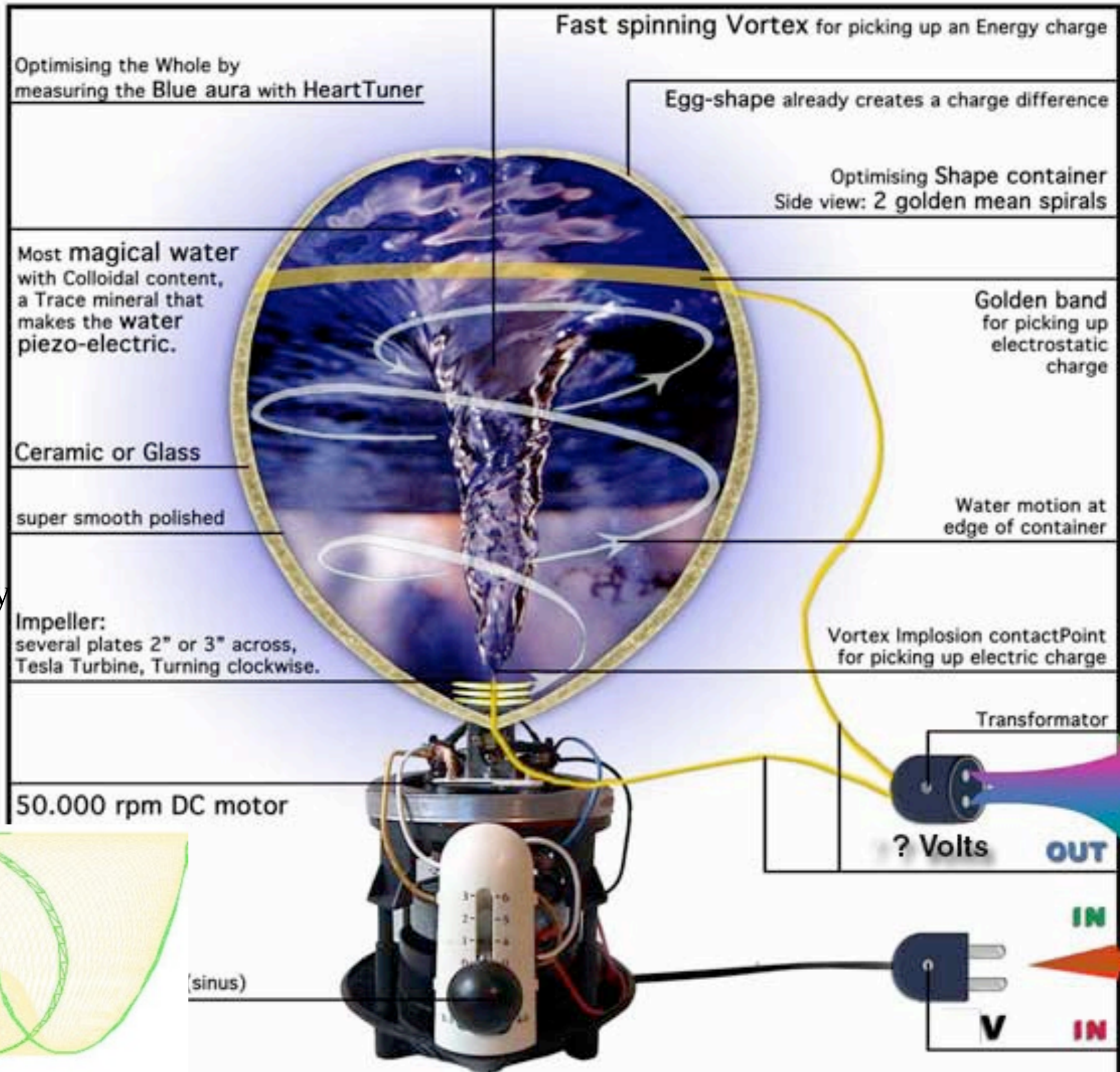

‘Ethereic Formative Forces’ (Steiner) are electrically described as Symmetry lines (Projective Geometry) which allow (Capacitive) CHARGE - to unpack as wave- constructively into Space.

Their self-organization by Implosive Compression - is called  
Conscious Self-Awareness  
(Symmetrically -from the Vedas: Ability to Self Refer..)

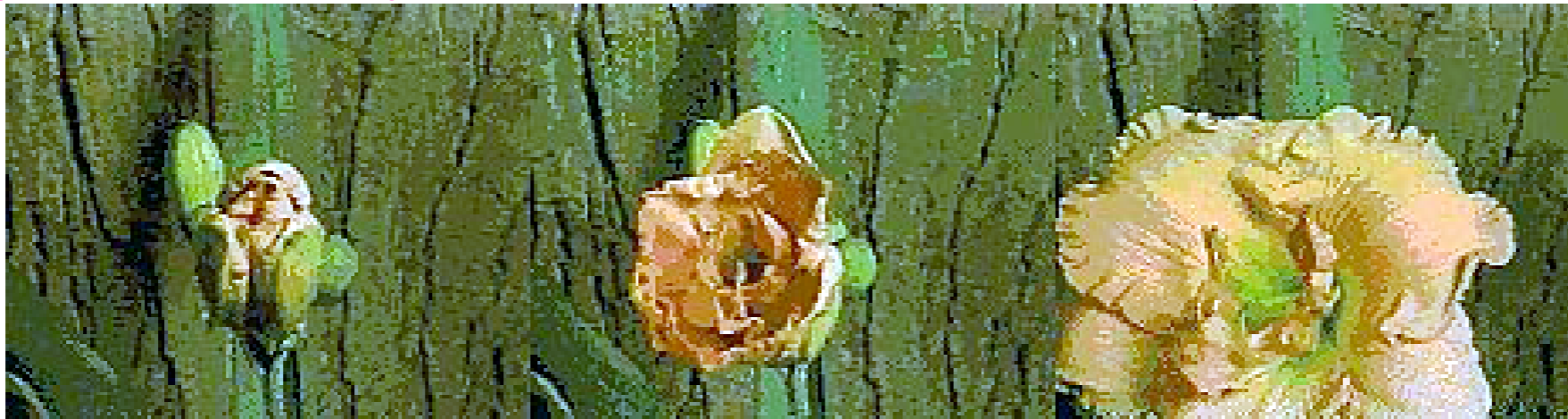

The Steiner student accurately visualizes a sequence of time lapse drawings of a bulb becoming a flower.

. The room FILLS with a *love growth urge* in all present there.

Then the same student accurately visualizes that rose stepping toward wilt and death -and the feeling in the room changes dramatically.

-Learn the sequence of symmetry turns in principle to CREATE.

‘Projective Geometry’ maps constructive wave interference paths

- a good way to check where to dream or die from.

The place of power uses symmetry knowledge to gain leverage on spin.



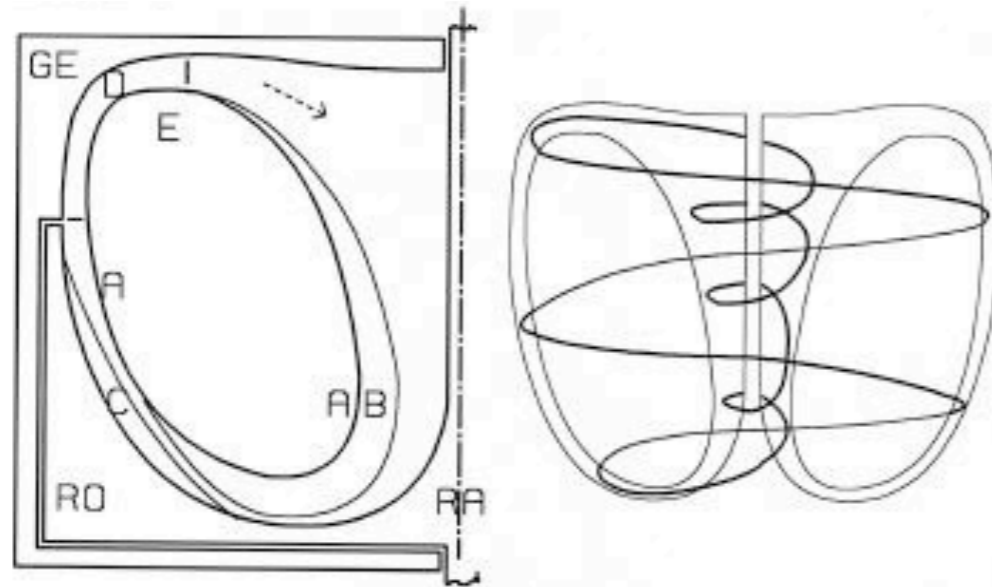

Schauberger's cold implosion

Schauberger knew the REASON:  
 His piezoelectrically (clay mineral)  
 doped Water Vortex EGG  
 was about to begin  
**GENERATING VOLTAGE**  
 from GRAVITY –  
 when it began  
 “spontaneously” getting COLDER  
 (heat is only a word for the opposite  
 of non-destructive compression).



The REASON –  
 was Phi / Golden Ratio  
 Recursion Symmetry in the  
 (Charge) Vortex ...  
**IMPLOSION**

Recursive Heterodyning  
Is the Constructive Wave  
Interference Which  
Produces Implosion /  
Self-Organization

*Waves must BOTH Add & Multiply in order*

*to produce  
only  
CONSTRUCTIVE  
interference.*

Golden Ratio

.618 series & recursive heterodyning

Varying the tilt angle (here, into and out of the plane of this paper) of the vortex cascade or "light cone" which the heart's vortical muscle was impedance coupling, would determine this critical RATIO between adjacent nested fields. And by this ratio, the geometric efficiency of the fields ability to couple and continue their cascade bringing information between large fields like planets gravity bodies, to glands, and into cells and DNA.

.618...  
1.0  
1.618..  
2.618..  
..

Add 2  
To get  
The next  
OR  
Multiply  
Any one  
Number  
Times  
1.618..  
To get  
The next.

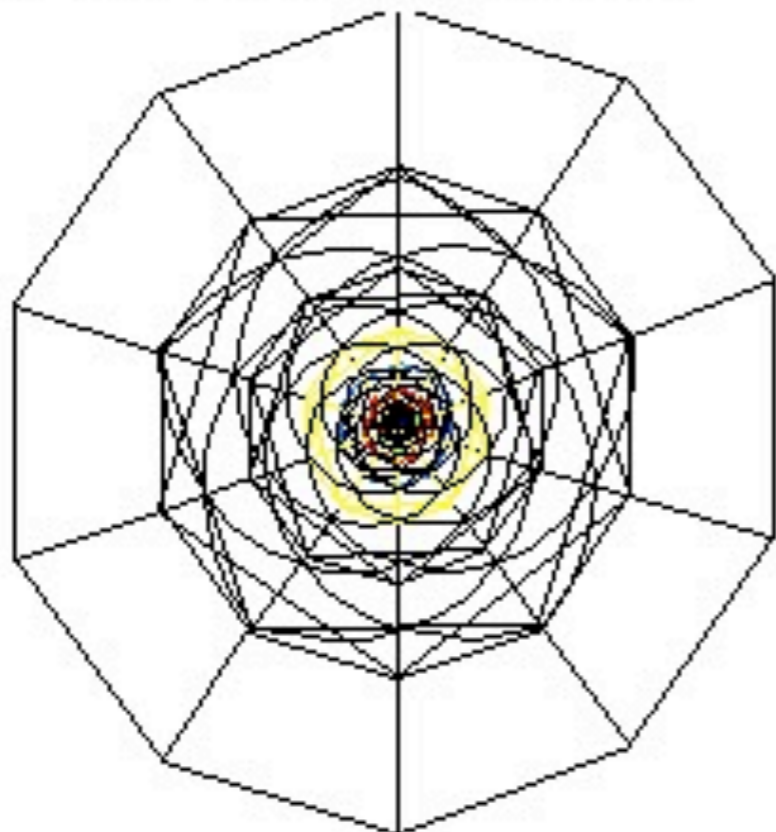

Here  
Is where  
Compression  
Becomes  
Acceleration..  
'squirting'  
Thru the  
Speed of  
light

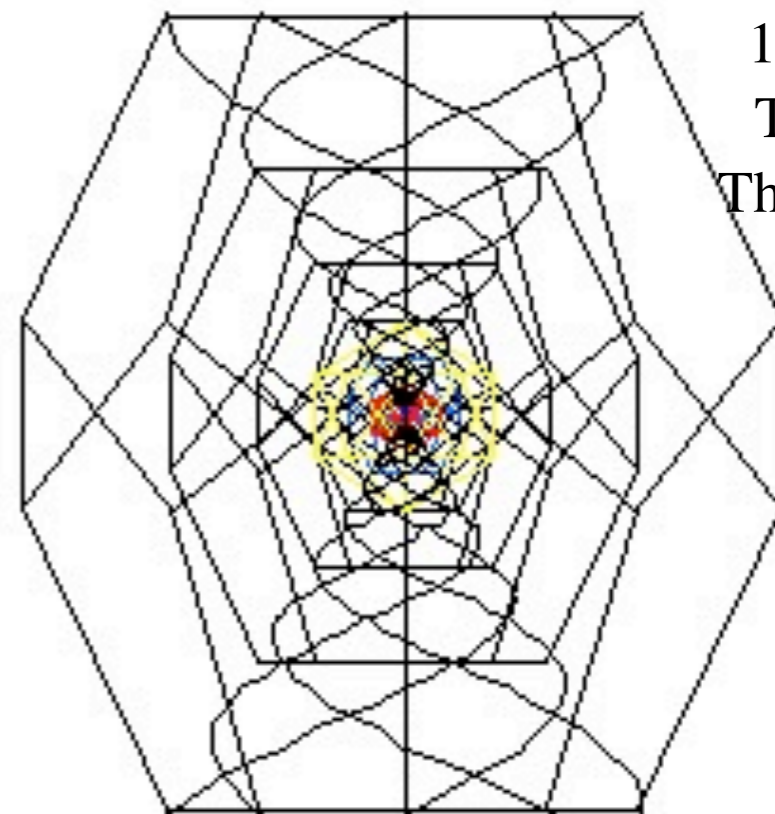

# Attraction Due to Gravity

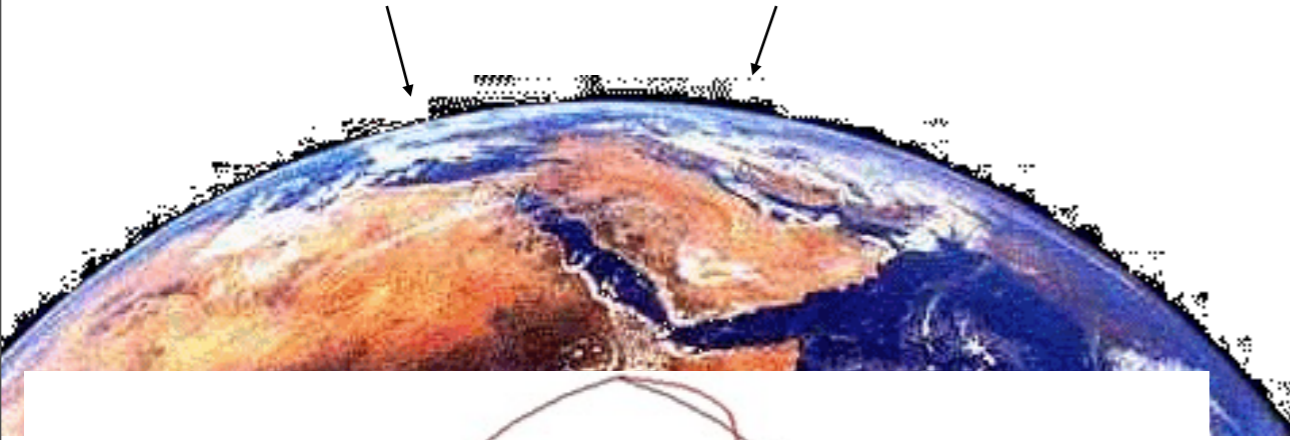

**Self Similarity (Golden Ratio)  
Creates Gravity because  
Infinite CONSTRUCTIVE  
Interference of (charge) wave  
VELOCITIES - turns Compression  
In to ACCELERATION (Gravity).**

**So the REASON an object falls to the Ground is:  
charge is being Sucked out  
thru the speed of light.  
This explains (Golden Ratio in)  
DNA's role in Fabricating gravity.**

"Sine Waves"



PERMITS ADDING  
AND  
MULTIPLYING  
OF WAVES

GOLDEN MEAN RATIO

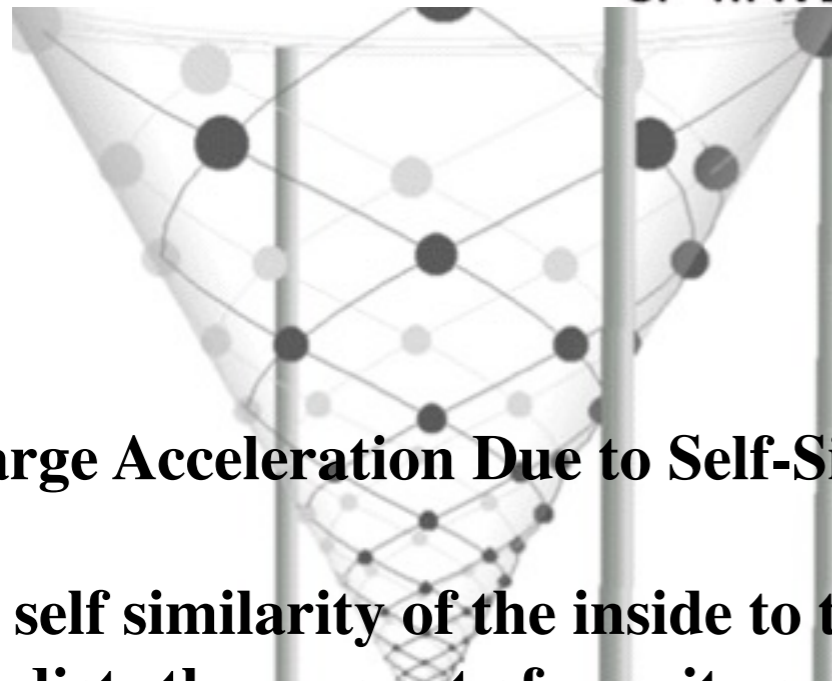

**Charge Acceleration Due to Self-Similarity.**

**"The self similarity of the inside to the outside  
Predicts the amount of gravity created by  
Atoms, DNA, Planets and Stars".. Winter**



**Tachyon Energy: When Golden Ratio Charge Self Similarity turns compression in to Acceleration - the resultant phase velocity constructive interference- produces connection to faster than light speed (meaning of Tachy-an) .**

**This Implosion / Fusion effect should never be called unlimited or 'free' energy because it is limited by the fractal coherence (collapse) of charge -called the gravity field itself. Organic material (in architecture of sacred space) for example- produce this effect (fractal) because the capacitive or electrical property of biology in general is FRACTAL - and therefore PHASE CONJUGATE (visualize caduceus).**

**Gravity is the magnetic monopole of infinite (fractal) charge collapse - due to this effect: self similarity heterodynes phase velocities constructively turning compression in to acceleration / gravity. In this way when charge gets a way out thru light speed the centripetal charge suction to center - centering force - acceleration to center- defines gravity. The amount of gravity in anything (atom/ DNA/heart/planet/galaxy) is limited by the collapse inviting self-similarity of its inside to its outside.**

**The turn orgone for example is a misnomer for directionally recursive capacitance - typical of molecular geometry which has been arranged into a fractal to breathe charge efficiently - thereby defining all biology electrically: Perfected charge distribution - storage goes to zero when fractal compression allows fractal charge radiance - also defines abundance in economics.**

- 2. "Sucked DOWN THE DRAIN?" - New information for physics: things fall to the ground because self-similarity makes a drainhole for charge out thru the speed of light. (Einstein WAS right that the symmetry of infinite non-destructive compression was the key to the continuum of electric charge to gravity - he was wrong not to see this demonstrated in the symmetry of every plant phylotaxis. )
- 3. Einstein's theory that accelerating charge thru the speed of light requires infinite energy - is proven wrong by every living protein. Living and fractal structures like pine cones, and the self-similar electrical fibres where the heart gets voltage from gravity to fire (perkinjole), and the self similar branches (alveoli) of the lung - create life because they implosively attract (capacitive couple) charge (from the gravity field).
- 4. Therefore we add - that self-similarity in biologic capacitance - is the CAUSE and maintainer of life- because this creates perfected charge distribution (earlier called the 'breath of life' or spirit). Logically extending the Vedic notion that the ability to self-refer defines consciousness, we now see that it is moreover - perfected (fractal) compression of charge which creates the perfected distribution of charge - which defines consciousness itself. (explaining for example why conductivity measurably improves when impressed with human 'intention' in Bill Tiller's latest book).

- 4. That DNA becomes stronger every time it enters biologically fractal (successful charge compressing ) environments - and weaker (dies a little) - every time it enters fractionating (non-fractal ) charge environment. In practice this means sacred space - caves, stone circles, labyrinths - enable life by compressing charge (biologic information) successfully into DNA. And the opposite is true - that persons who persistently inhabit bleeding capacitors ( metal buildings, capacitive charge depleted air {air'conditioning'} etc., non-fractal electromog) will electrically shorten the life /implosion of their DNA.

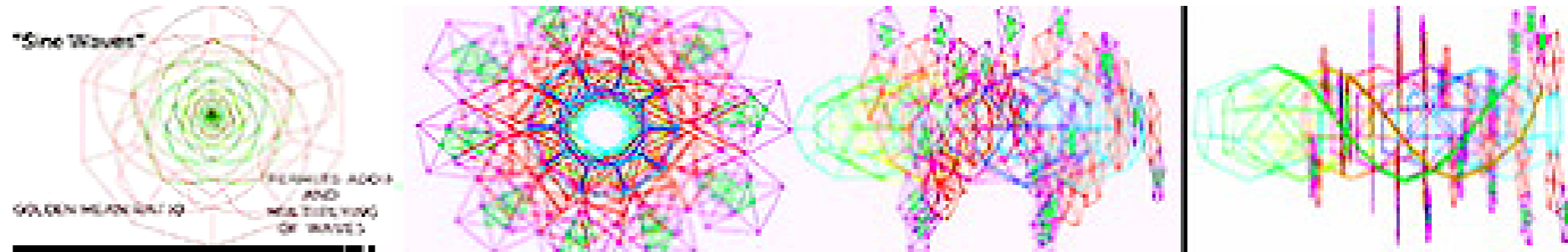

- 5. That DNA - in the necessary and survival required process of becoming electrically sustainable - must

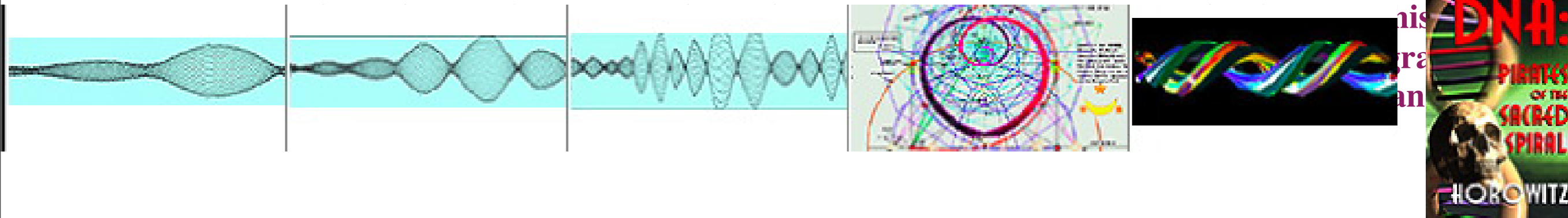

The blue ultraviolet- FLASH ( moving toward faster than C lightspeed)

- **6. That all systems which become self-aware and thereby apparently self organizing do so specifically by arranging themselves into the optimized charge distribution which results from Golden Ratio fractal compression - accounting for Golden Ratio in phylotaxis, in every (Pent) living protein, and the (Golden) spiral nature of star systems, galaxies and time itself. (aka Carolan book: 'SPIRAL CALENDAR' )**
- **7. That apparent synchronicity, and the inhabiting of time ( a measure of relative rotation) is only sustainable when time (the symmetry of event histories in time) is also Golden Ratio and fractal.**
- **8. That all parts of life which do not ultimately obey this simple law - get charge fractal or die ( - like most poisonously metal - refrigerators, buildings, cities, and bioregions on Earth today - ) will die sooner rather than later. ( list of materials that create fractal and therefore sacred charge space for architecture- and all life - - see : [soulinvitation.com/architecture](http://soulinvitation.com/architecture) )**

Searl  
/ Townsend  
Brown  
Gravity  
Thrust  
Effect  
Created  
by Curved  
Capacitance  
Measured at  
JL Naudin Labs

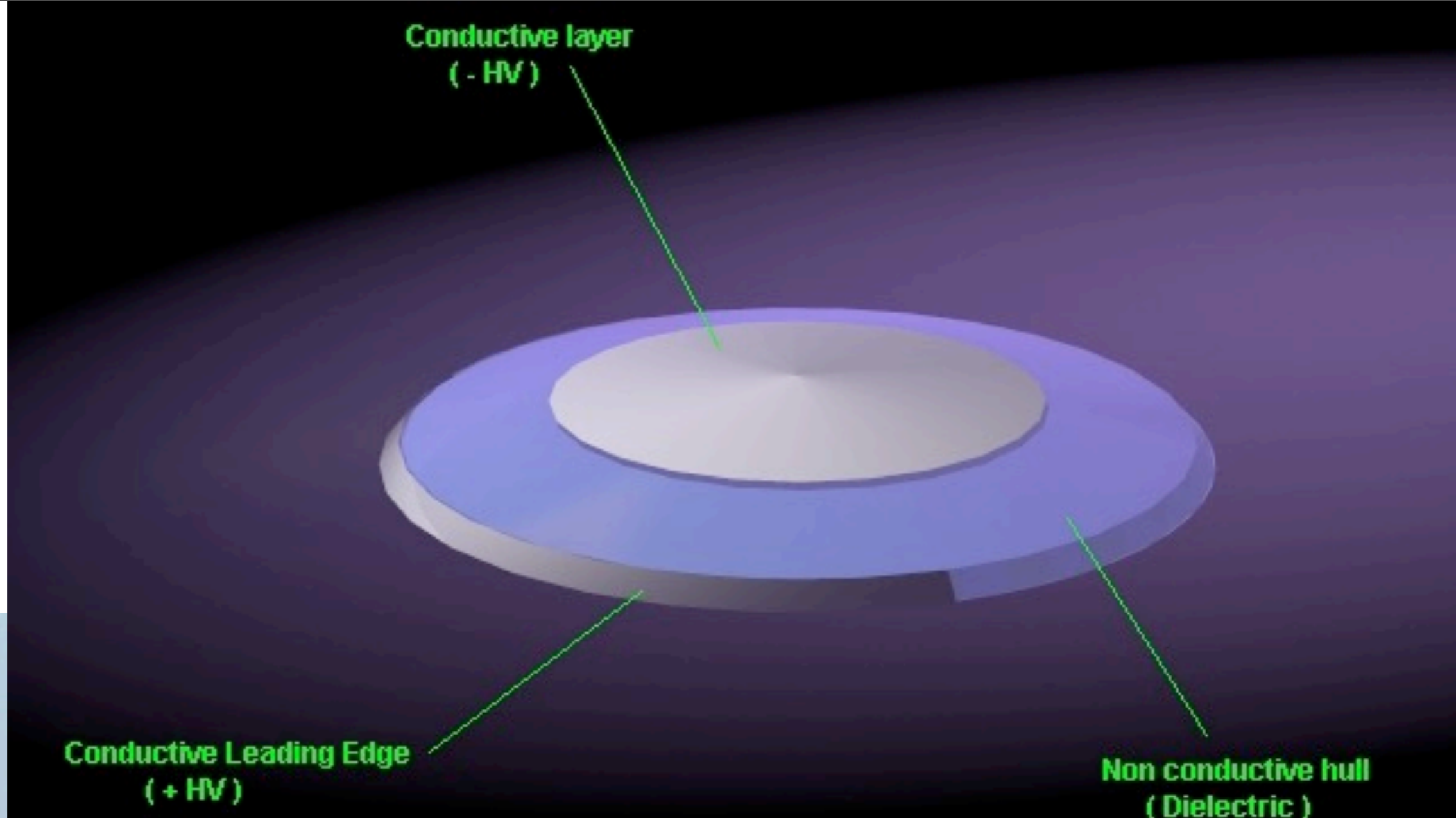

The Enhanced Townsend Brown Electrokinetic experiment by JL Naudin  
September 22th, 2001 - Email: [jnaudin509@aol.com](mailto:jnaudin509@aol.com) - <http://go.to/jlnlabs>



*Root 5  
Basis of  
Golden  
Mean  
relation*

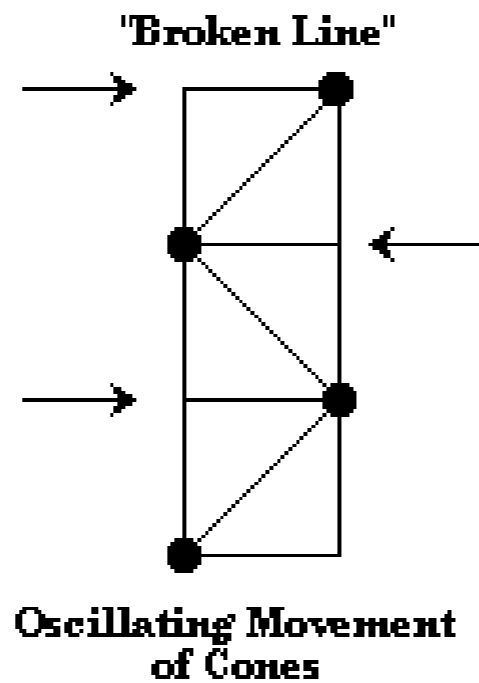
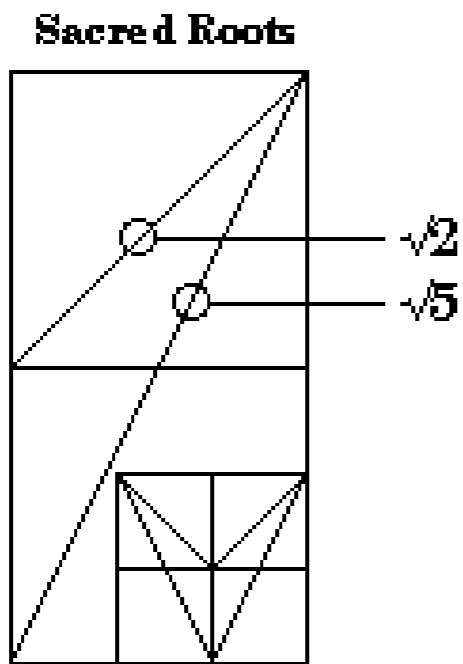

## Egyptian Djed

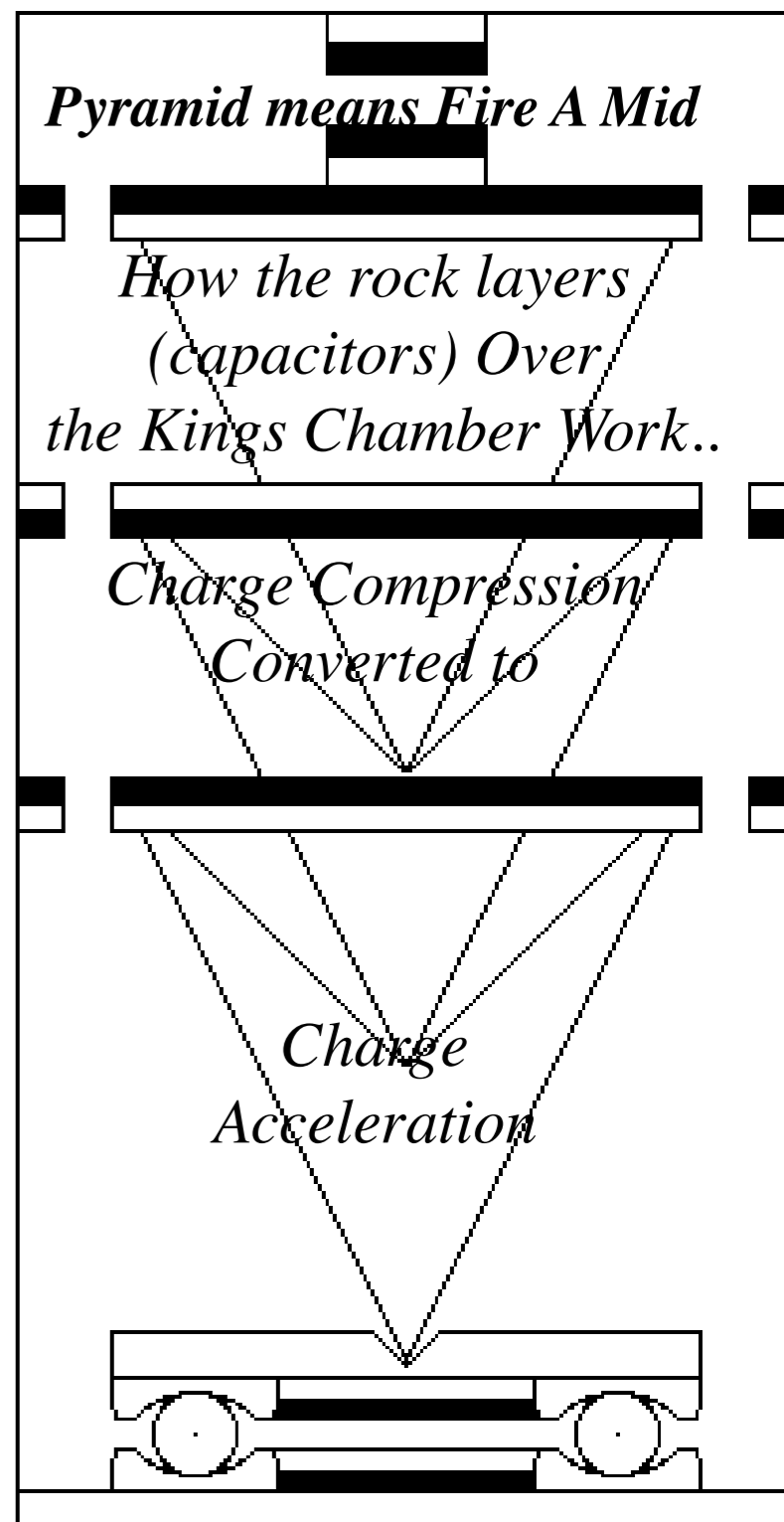
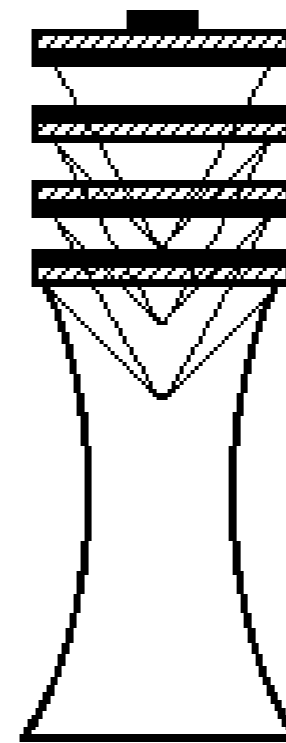

*French "Naudin" Gravity Thrust  
Device - by Capacitors Arranged in Cone*

*Originally inspired by the geometry  
Of Egyptian Concept "Djed"*

*Also:  
'Mygdala':  
To TOWER*

*Raising of the Djed - versus- Djedai Knight..*

*Compare to Sword and the Stone... Creating ~Vertical Component  
To Magnetism originally in rotation.. (Golden Ratio Path -  
Translates Vorticity from Circle to LINE..)*



**"Paying your debt to Gravity" is to embed..."**

**"The proportion of charge recursion below you vs above you is the amount of gravity (wind of charge?) you feel.."**

**The amount of gravity created in an atom (or ANYTHING) is in proportion to the relative amount of SELF-SIMILARITY (Fractal Embedding) between it's inside (nucleus) to it's outside (electrons).**

**This facilitates the permissive collapse thru light speed by recursion - which tornado connects the our inertia below light speed to the intelligent gravity metabolism of star systems solving the incomplete 'fall to chaos' entropy idea of thermodynamics. The fundamental mistake was not to understand the SELF ORGANIZING vortex geometry of compression making the connection BETWEEN scales (scalar / torsional) . A human fabricates gravity in their EKG and DNA by learning to steer waves into this painless (non-destructive) compression: known by the psychological name COMPASSION.**



**"Grounding is the same symmetry operation in electrical theory as it is in psychology: your wave inertia (information) getting access (embedding in ) the LARGER fractal (environment)."**

*Cone over 1 meter wide, set up at the correct 60 degree  
Dodeca embed stellation angle to accurately position capacitors  
To fabricate gravity from voltage, and the reverse..(photo from Perth)*

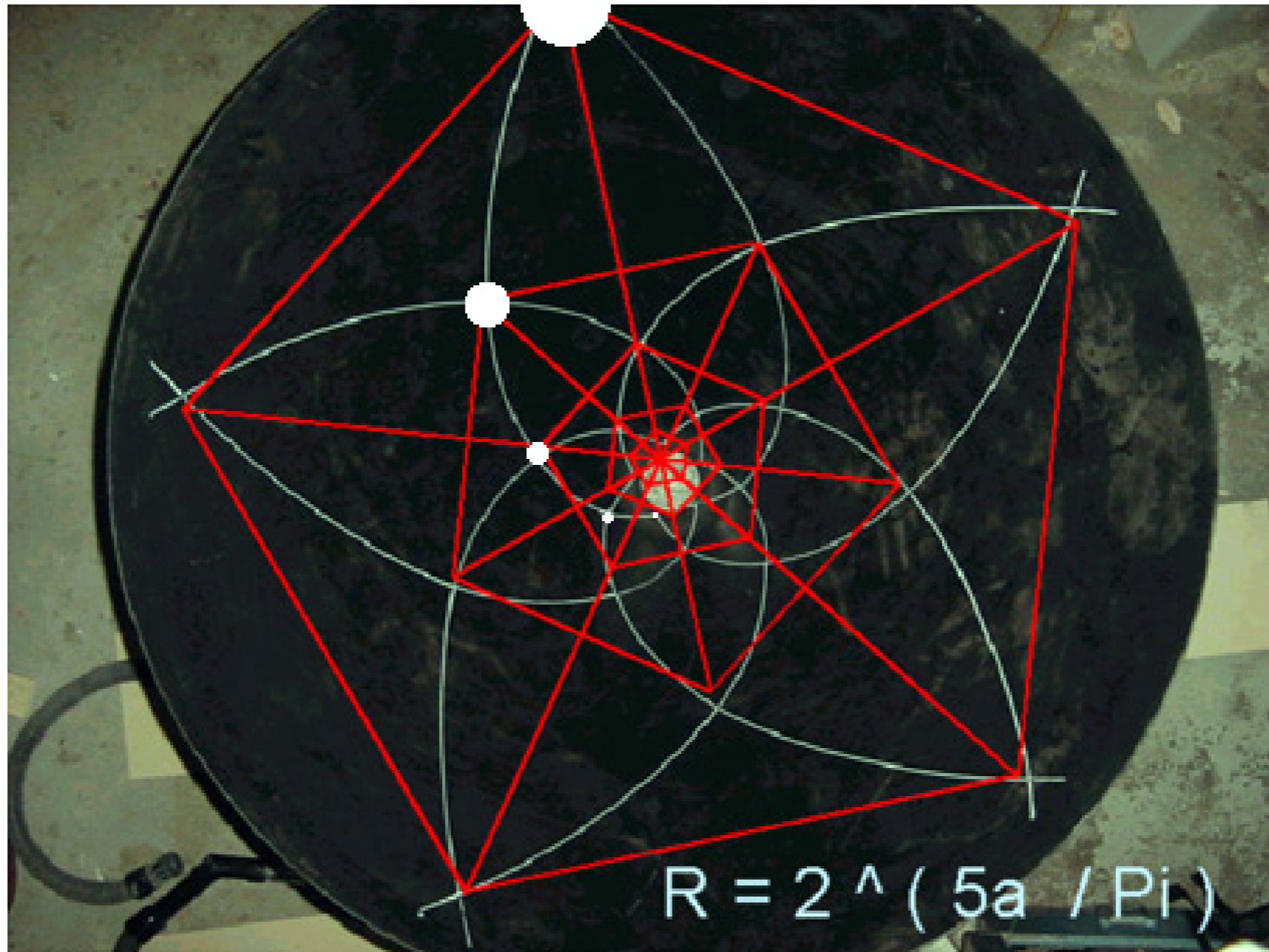

# CAPACITOR ARRAY GRAVITATIONAL WARP DRIVE ENGINE

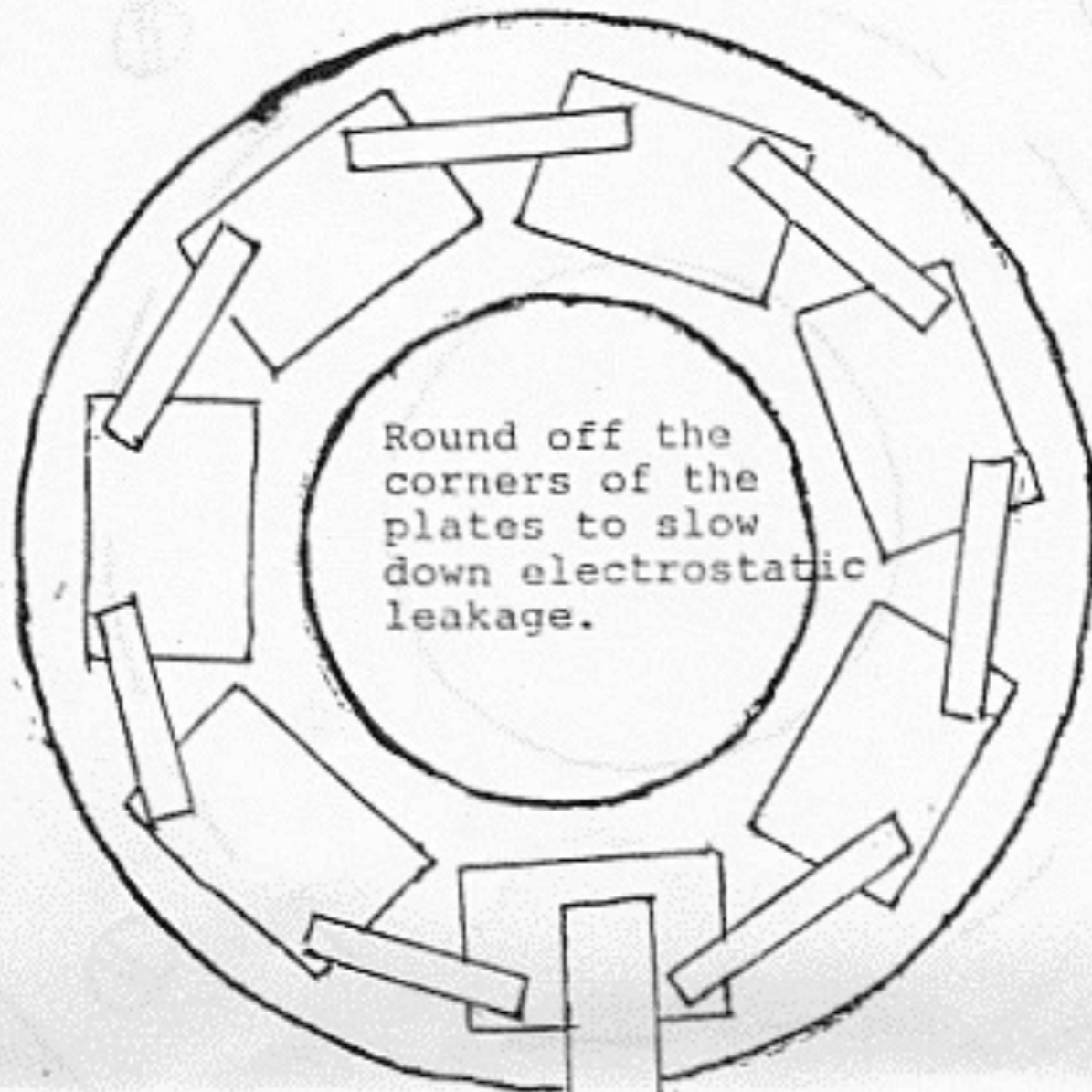

Round off the corners of the plates to slow down electrostatic leakage.

Use waxed paper for the dielectric. Cut it into rings, as illustrated, with large hole in center. Use TIN foil (NOT aluminum) as "plate" material. Make sure to "center" the plates on the dielectric, so as to leave ample margin between outer and inner edges of the dielectric, as this is vital to proper functioning.

Connect the plates to each other using very thin strips of tin foil, laid on top, and set toward the outer edge, but not going beyond the edges of the plates. Leave a long, thin strip of tin foil, laid on top of a plate, and extending out, to be used for charging the array.

You will have to stack hundreds of such layers (use TWO waxed paper rings on each layer)

Leave the positive charging strips aligned on one side of the array, and all the negative strips aligned on the other.

When the array is completed, you just roll and crimp them together, in bunches of two dozen or so, tack them with solder (don't damage the dielectric)

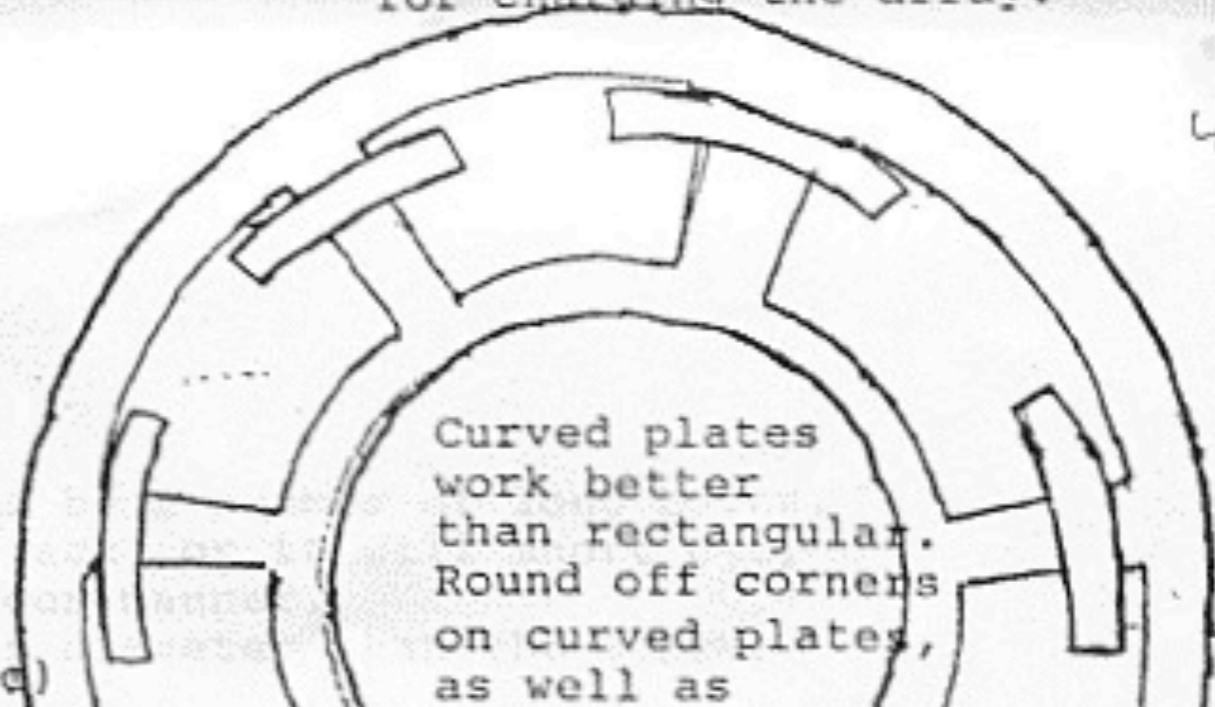

Curved plates work better than rectangular. Round off corners on curved plates, as well as

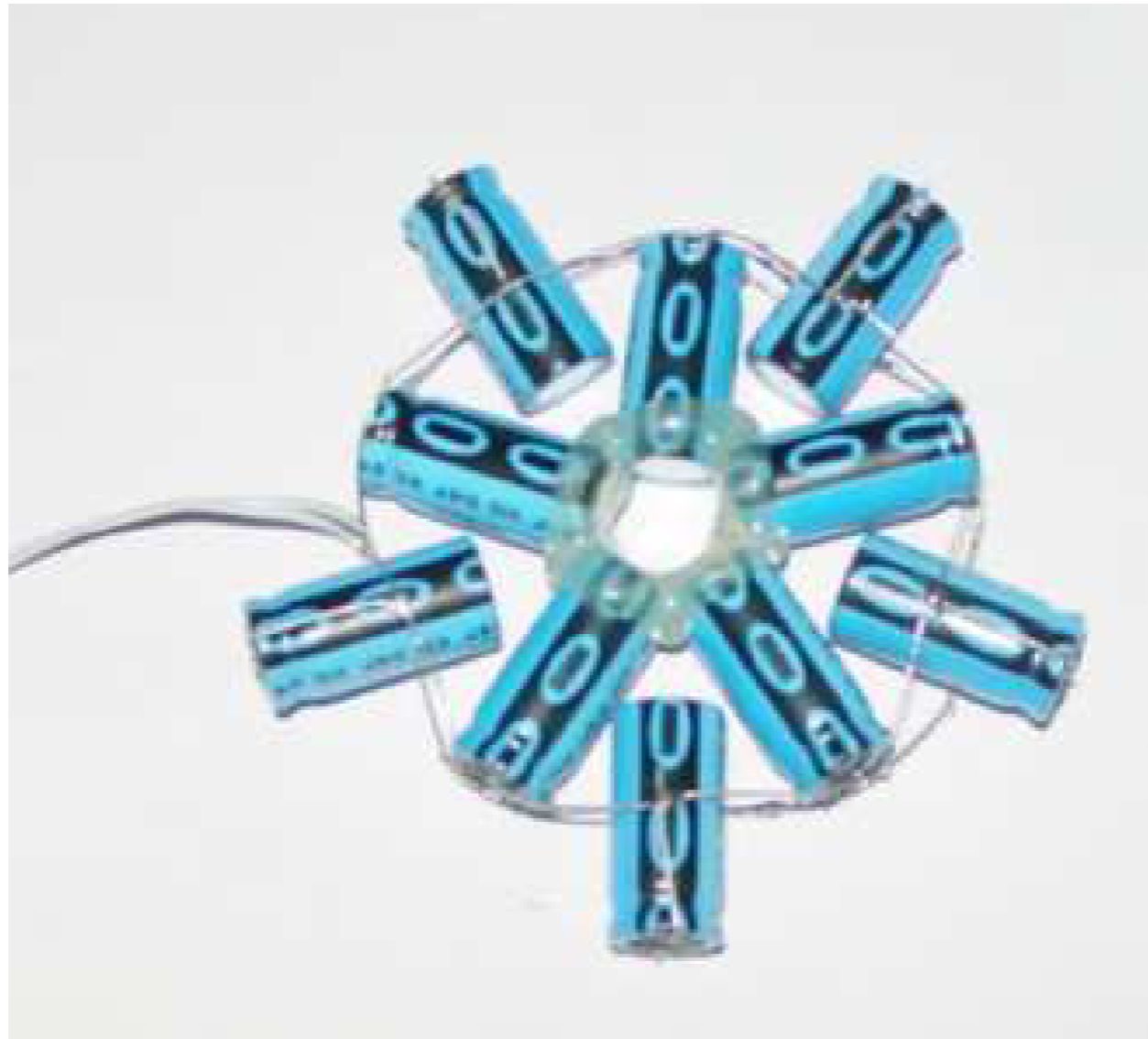

Experimental Implosive Capacitive Circuit  
Sept 05 - Triggered Storm as it was first Energized..

**The Word 'Relativity' is obsolete to describe the relationship of mass to energy because that relationship (which allows charge to compress and thus be called MASS) is more precisely FRACTAL. Namely: self-similarity perfected allows charge (energy) to compress (non destructively) and thus become MASS. Fractality (of charge) creates MASS , life force, and self-organization (because that is what permits implosion). That path permitting non-destructive charge compression simultaneously produces charge ACCELERATION - (recursion in velocity heterodynes) which is the only source of the phenomenon called GRAVITY.**

*Arranging capacitors (in concave array / toward recursion) to fabricate gravity has been done many times (Searl, Townsend Brown et al. , & in Stealth aircraft - predicts the death of rocketry) - Winter is merely the first to describe the principle which caused it.*

**E=MC<sup>2</sup> merely quantified the obvious that inertia storage - called 'mass' was only a function of sustainable wave rotation.**

**More interesting / and from the point of view of electrically supporting the creation of life force - probably more useful - we now know: Gravity, Implosion, and Self-Awareness = Charge Acceleration thru C by Wave Self-Similarity - FRACTALITY ! = (Potentially infinite wave multiple-connectedness by CONSTRUCTIVE COMPRESSION)**

**By design & by braiding, capable of so much self-similar  
implosive compression:  
DNA SQUEEZES biological magnetism  
Thru the speed of light into GRAVITY WELLS..  
Fabricating Gravity.. As the geometer of consciousness it's  
Symmetry inserts the embedding which keeps little tornadoes  
Nested inside bigger ones...**

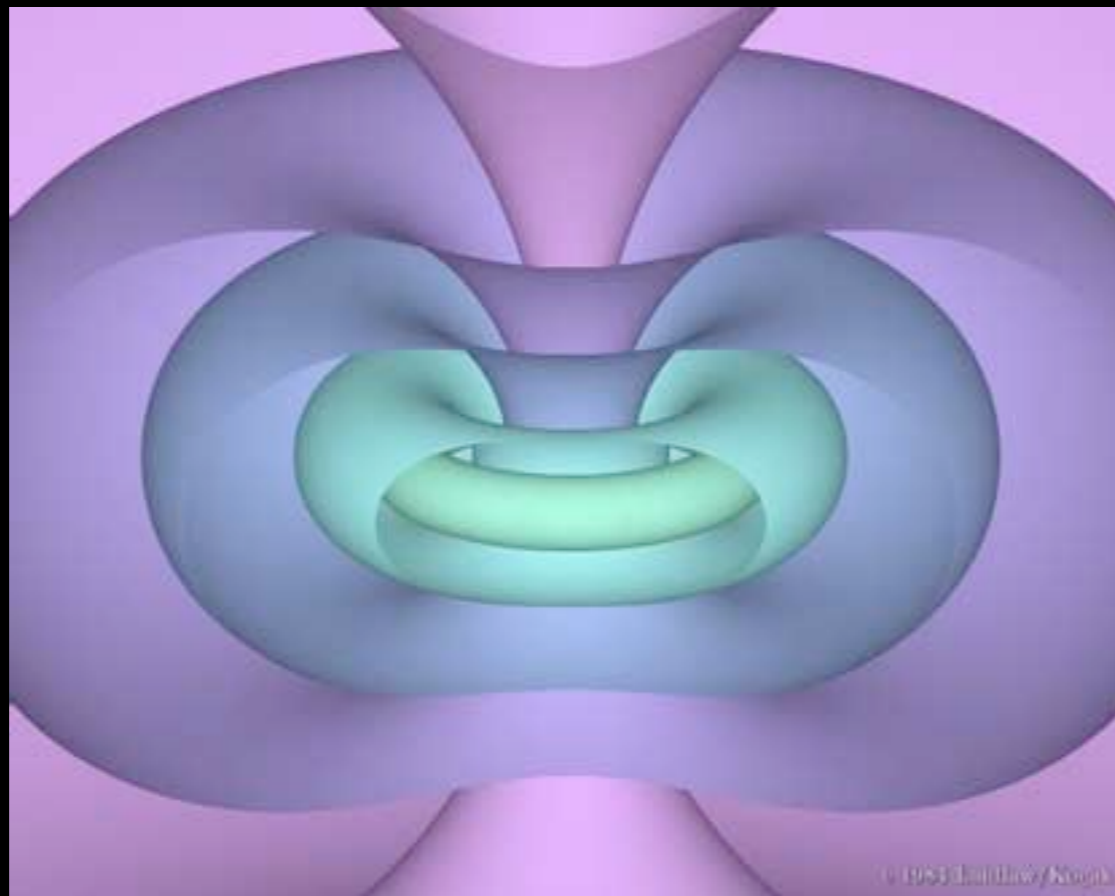

**Thus consciousness as embedding  
(self-reference) maintained  
Becomes the physics of the GLUE  
Which holds fields together.**

*Science shows..  
Love is the GLUE  
That Holds things Together*

**Infinite Non-Destructive Compression - because of recursive adding and  
Multiplying of wavelength AND velocity - PRODUCES the acceleration  
Einstein knew is identical to gravity.**

**The FIRE of BLISS in your BLOOD (The field effect of emotionally COHERENT (ringing) DNA )  
is a gravity making ‘Dreamspell’**

**Simple science now confirms the Mayan wisdom:**

**“Unless the DREAMSPELL of the ‘Old Ones’  
is alive and awake in symmetry space - Earth will be ‘blown away’  
in the magnetic wind of the Sun.”**

**•Solar Flares measured  
deflected when millions  
of children sing together.**

**•Weight loss accompanies dying**

**•Radioactive half life reduced  
measurably using only  
Focused attention.**

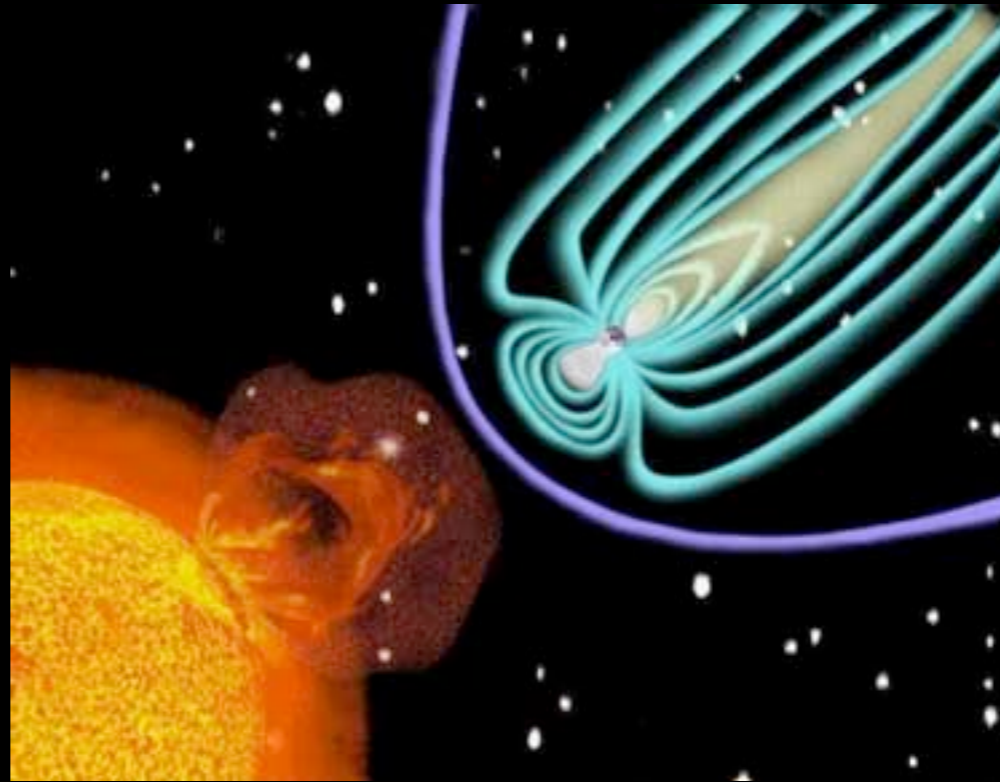

**?  
Global Coherent  
BLISS experience:  
“Harmonic Module”  
Solution to  
Solar Maxima  
(2004-2012)  
potential destruction  
by compression  
(The ‘rapture’)**

**In addition to it’s role in Gravity making.. (“Songline” wormhole maintenance..?)**

**When the ‘zipper’ up the long axis of DNA braids or knots  
To accelerate thru light-speed sustainably -- this facilitates  
Lucid dream, and sustaining memory thru death... “ensoulment”**

**This is the problem genetic engineers lost by calling the braid SPACE between  
Replicating codons “Junk DNA??” -- the souls of children...**



The implications of the possibility that humans can influence the Sun are tremendous and suggest a number of other international peace projects that could be developed in the new few years.

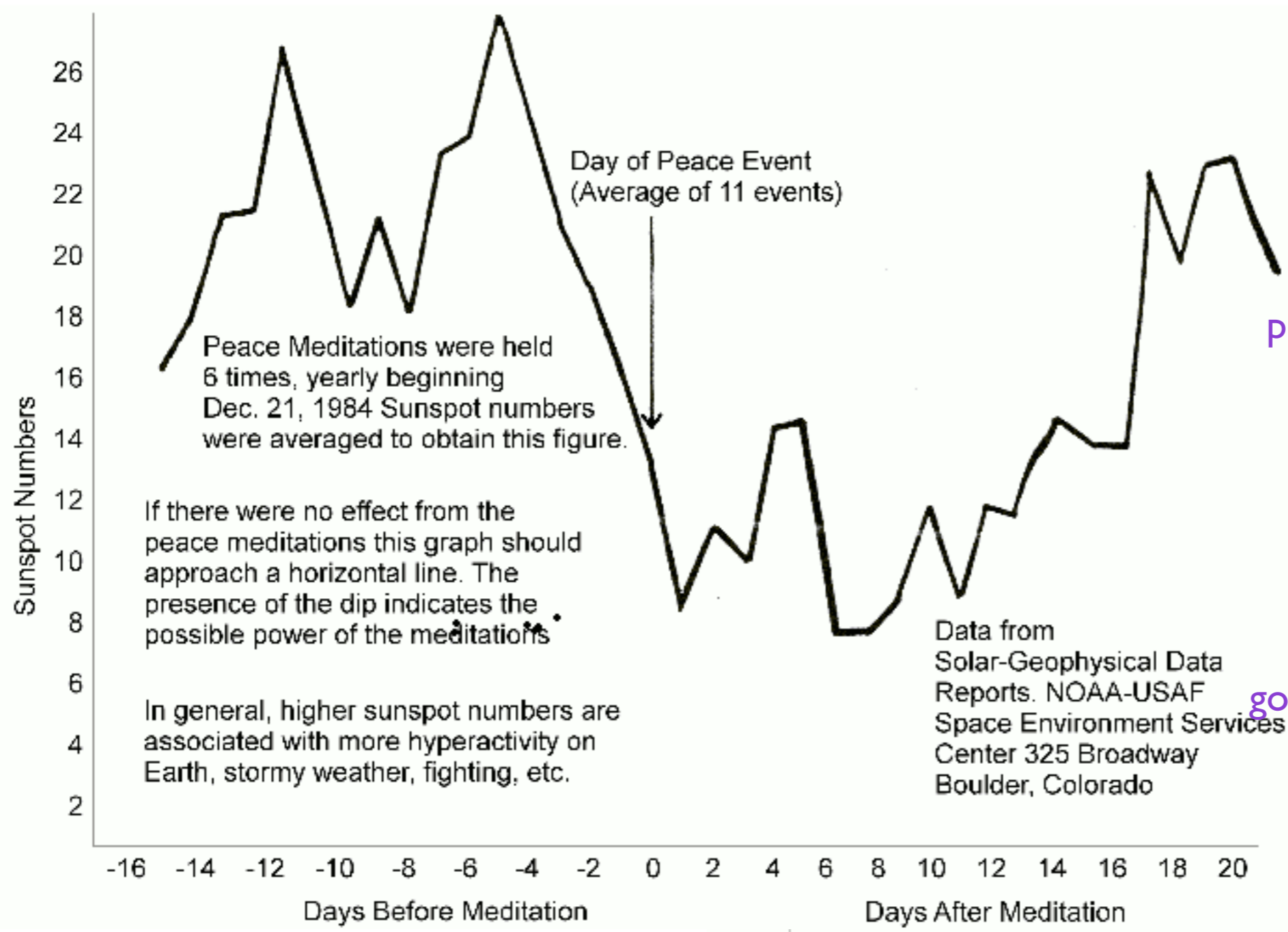

When Millions of People meditate or sing in Synchrony their bioplasma makes a centripetal force (phase conjugation produced by peak perception) which measurably effects solar flares. We begin to see how solar plasma wind (2012 / 'rapture') is a tornado - we can learn how to steer: [goldenmean.info/whaledreamers](http://goldenmean.info/whaledreamers)

Final 12th meditation, NOT included in the Average (graph above), yet shows that the shapes of the graphs to be remarkably similar!

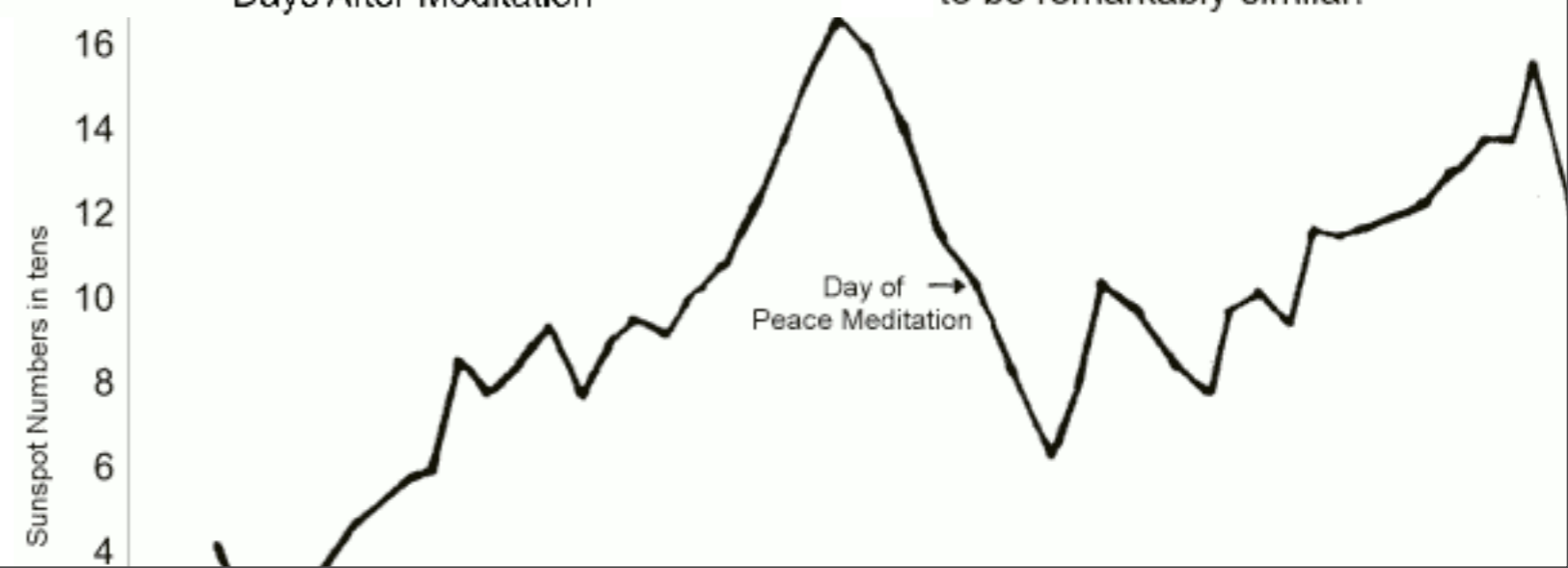

**The G generative wave –being how to DIMPLE – to think more about how the EGG and it's place of DIMPLING – connect DNA's fusion electrics with the Earth grid – and the aboriginal SOUL SEEDING POINT ( thanks to Richard O'Neill– for suggesting)– we reprint here from – "Vivaxis Energies Research International Society – Vivaxis is a term coined by Frances Maude Nixon (1910–1984), a Canadian woman who lived on Thetis Island, B.C. and spent almost thirty years conducting pioneering research in this field. Vivaxis derives from "life" and "centre" and it refers to a unique energy flow that connects an individual's energy field or etheric body with that of the Earth at the time of birth. The link functions as a two–way connection between the individual and their place of birth and the connection remains even as an individual moves. Each person's circuit has a unique individual frequency. The Vivaxis connection can be harmed or distorted by chemicals, electromagnetic fields or even lightning. It is believed that a disturbed Vivaxis connection can make an individual ill but restored and vibrant, the connection can keep a person healthy. ".. end quote**

**How the aboriginal gets his Title Land Deed at birth: At the moment where the mother FIRST FEELS her baby move in her womb– she runs to the shaman and they paint a map of the magnetic Earth lines FOR THAT PLACE – on a stone. Which is later gifted the baby as the title deed to which lands he/she will be custodian for dreaming (braiding into electrical coherence).**

# The Ge in George, Gaia.. Geode, Geodesic..

- tribes in Mexico and South America believe that Galactic Center or Tula emits a frequency or tone known as Ge, and that this tone not only heals the body and mind but brings immortality. The spiral Ge shown here represents the frequency being transmitted from Tula or Galactic Center.–

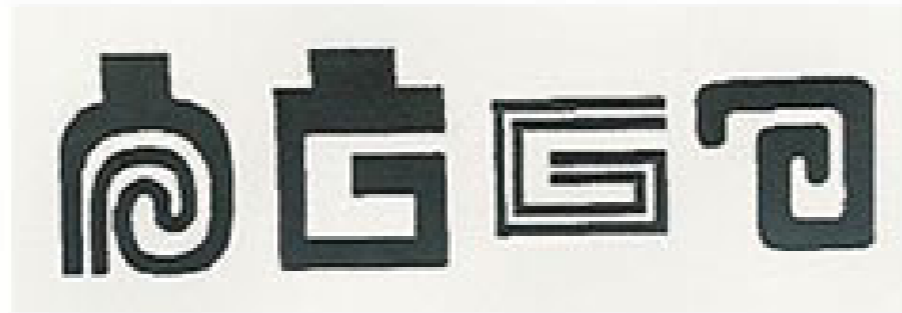

from: Vivaxis Connection: Healing Through Earth Energies

that the daily and monthly tides involve forces which are related to magnetic north and south. Her use of the terms gravitational and magnetic do not always correspond with the usual scientific understanding.

Much of this book is concerned with exploring the Vivaxis energies which appear to be those etheric forces which connect us with the earth in a two-way circuit which flows up one side of the body from the Vivaxis, and back down the other towards the Vivaxis (see Diagram 1). No matter how far we travel from our Vivaxis, we remain connected and can be recharged via its connection to the earth. However, there are many forces both electromagnetic, chemical and psychic which can interfere with our Vivaxis channel and it is important to be able to diagnose and clear ourselves of these disturbances. In chapter 5 we will take up the subject of the Vivaxis in further detail with exercises for finding its direction and use.

In the meantime, with the above thoughts in mind, we start in

Diagram 1

DIRECTION OF TWO-WAY FLOW FACING OUR VIVAXIS

“Vivaxis”:  
An Example of  
Fractality in DNA...  
Arthur (the ARC  
on the Torus) are ONE..

Vivaxis  
sphere

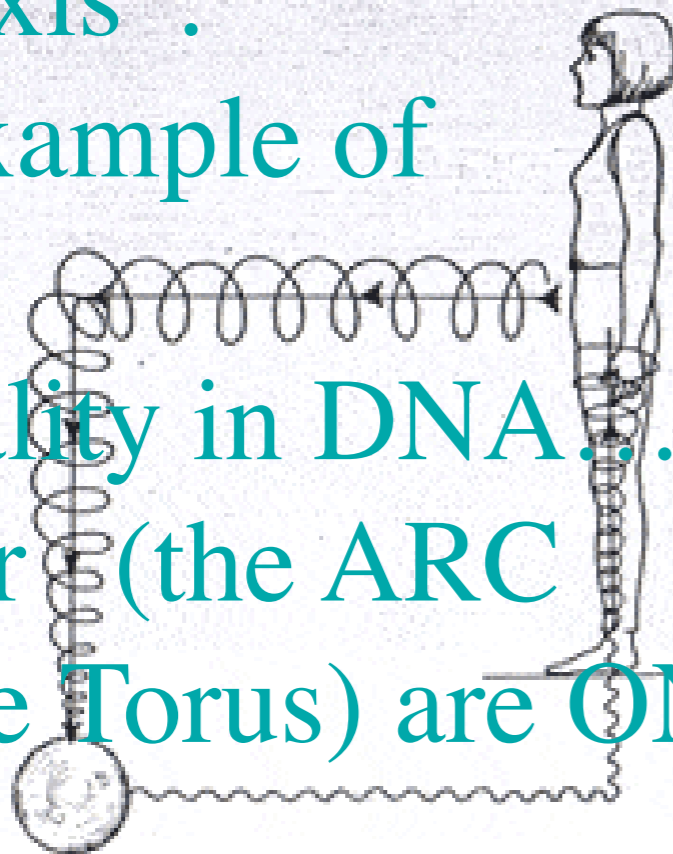

Vivaxis forces remain whether we are near or far from our birth location.

this chapter to explore our life energy as it relates to mother Earth and to explore some techniques which will help us to absorb the life-giving energies of our planet.

As a natural therapist I have used therapies for decades to give people more energy. However, in conjunction with our psychological state, our basic physical lifestyle and environment must always be understood as the backdrop for any therapeutic aid. If we compromise the integrity of our body energies, the effect of vitamins, minerals, herbs, homeopathy, or Vivaxis energies is greatly diminished – like pouring water into a bottomless pit. Some of the ways we diminish our health include poor diet, a noisy and polluted environment, introducing conflicting energies from man-made electrical sources, and negative thoughts and emotions. So our first task on the road to better health is to free the body from those disturbances which cause a conflict of energies.

## OUR FACULTIES FOR FINDING PLANETARY DIRECTIONS

We have looked briefly at the subtle parts of our constitution and at the concept of human beings, and Earth, having interconnecting and interpenetrating energy fields. We have highlighted the role of energy in both the macrocosm (planet) and microcosm (man). I believe that in the future human beings will learn much more about themselves in both magnetic and electrical terms. However, we must not be restricted to the present understanding and measurements of physics. There are electrical polarities and magnetic affinities and fields at the etheric and more subtle levels and our physical instruments can only take measurements indirectly. In this book you will learn to use your body as an instrument for sensing and testing these energies.

As suggested, we already experience ourselves as being composed of many subtle interacting fields and vehicles. Therefore we can use our own etheric body as an instrument for evaluating etheric energies. We can devise and repeat experiments where we can check our findings with others and thus bring repeatability and cross-referencing into our research. We can even devise experiments where neither the tester nor operator knows the nature of the materials being used – the famous double blind trials of medical science. In other words, we can work in a scientific manner using our body as an instrument.

Careful discrimination will enable you to distinguish between

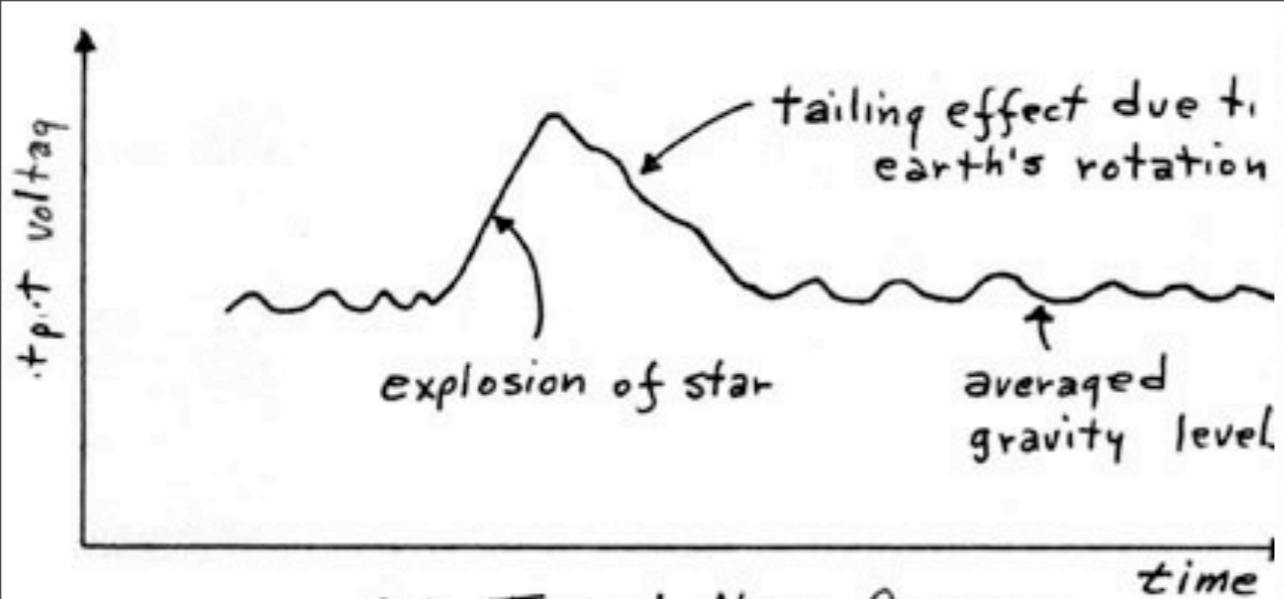

(a) Typical Nova Response

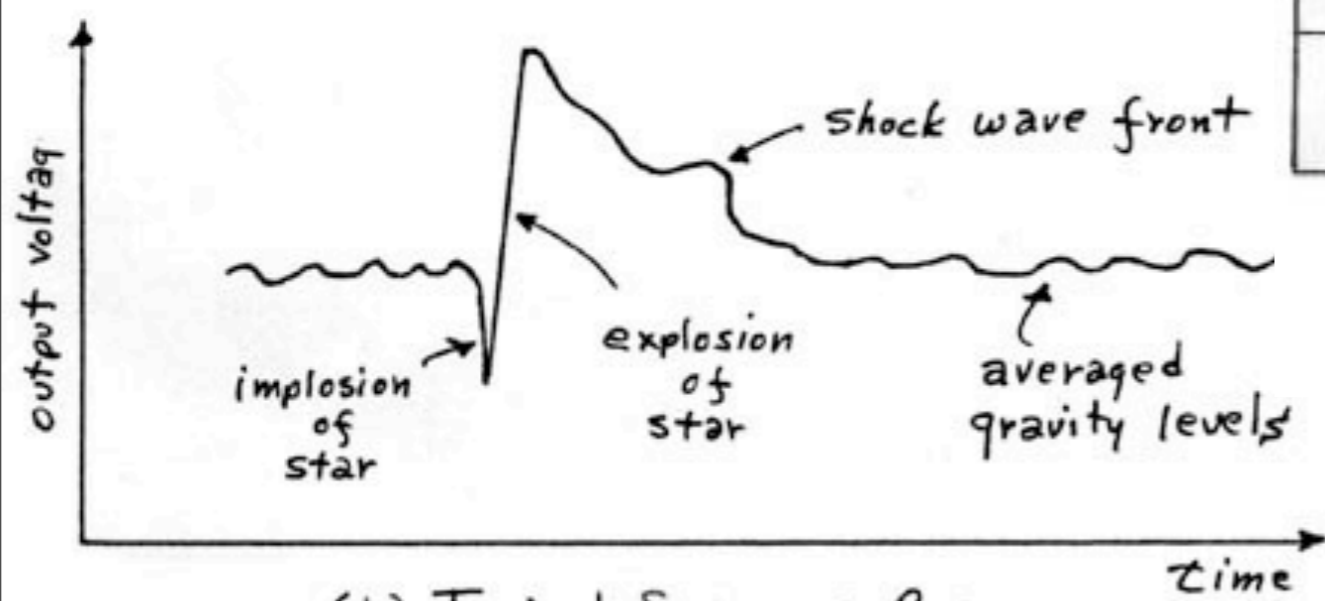

(b) Typical Supernova Response

Random number generators are merely a crude way to graph the output of a sensitive capacitor

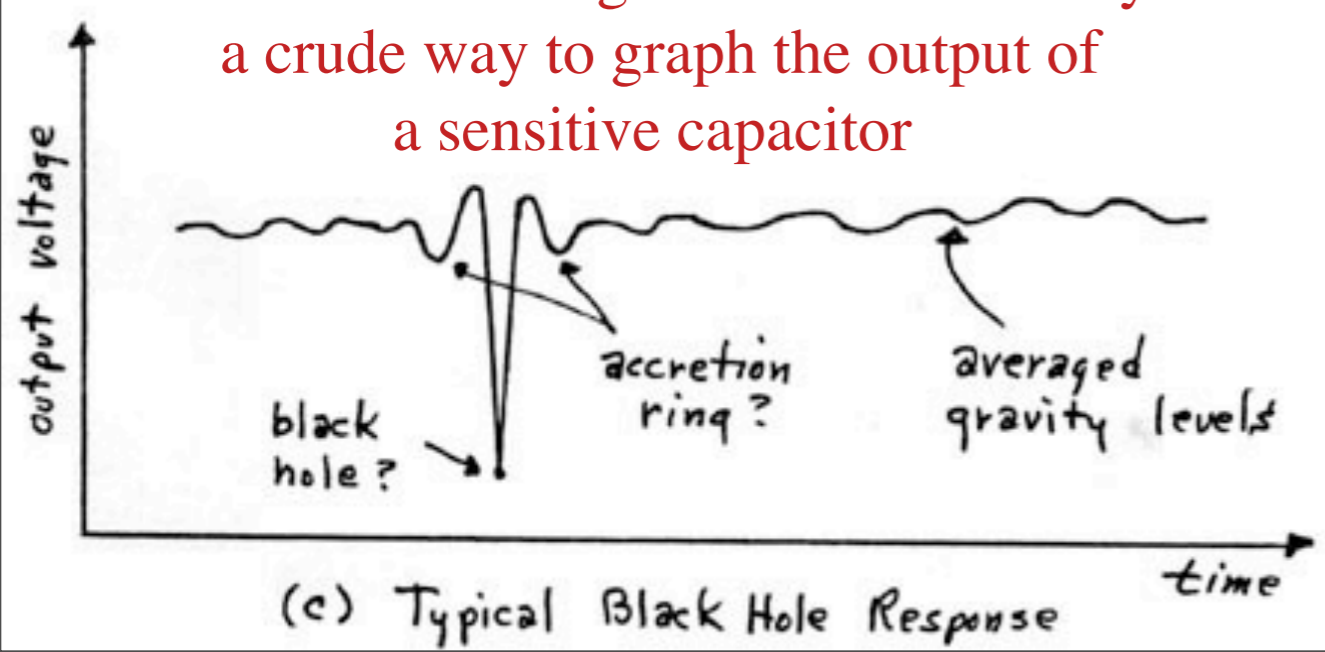

(c) Typical Black Hole Response

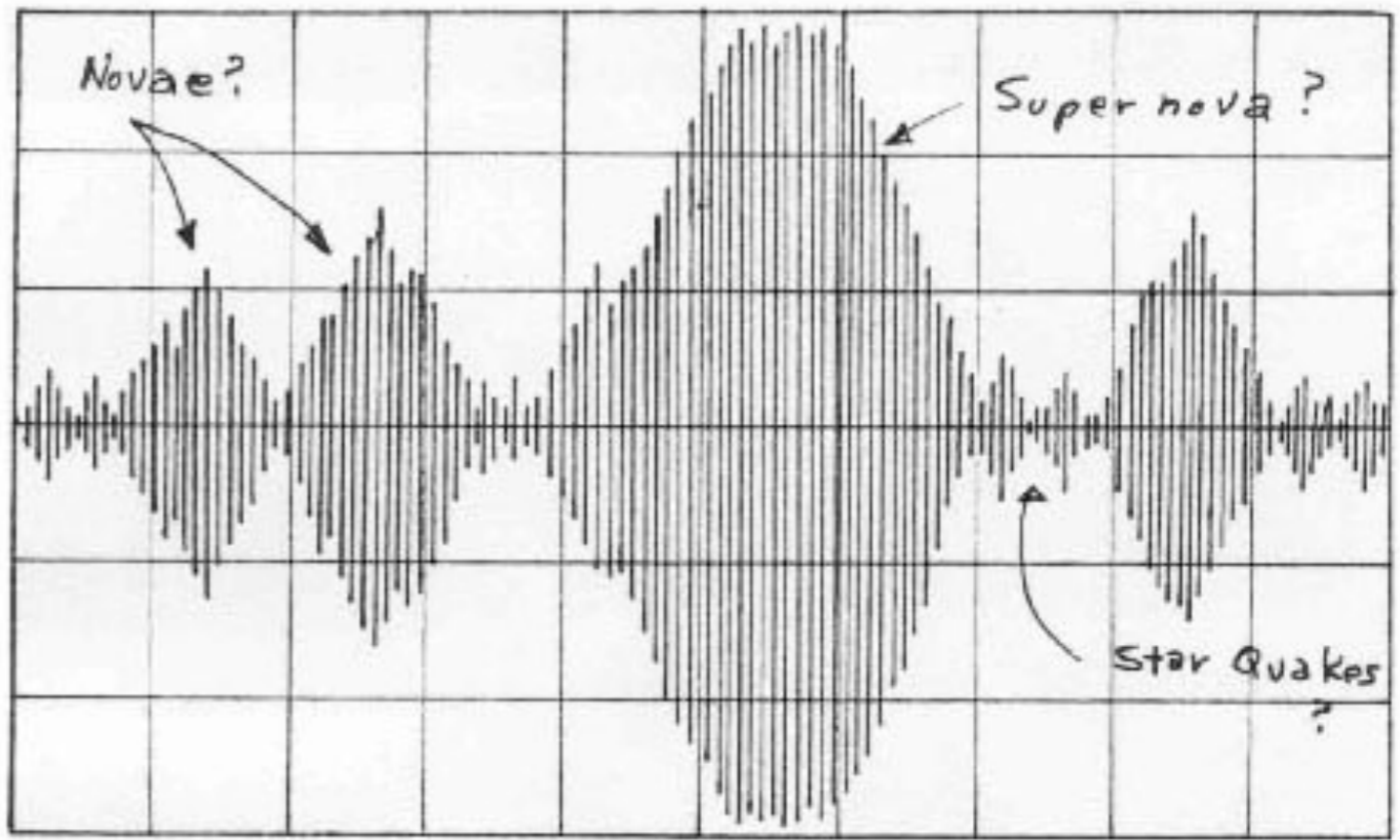

Vert. 05V/cm  
Horizontal 20m/cm  
Ring 550 cps

### Hodowanec / Ramsey Measuring Stellar Gravity Events With Capacitors Replaces Telescopes

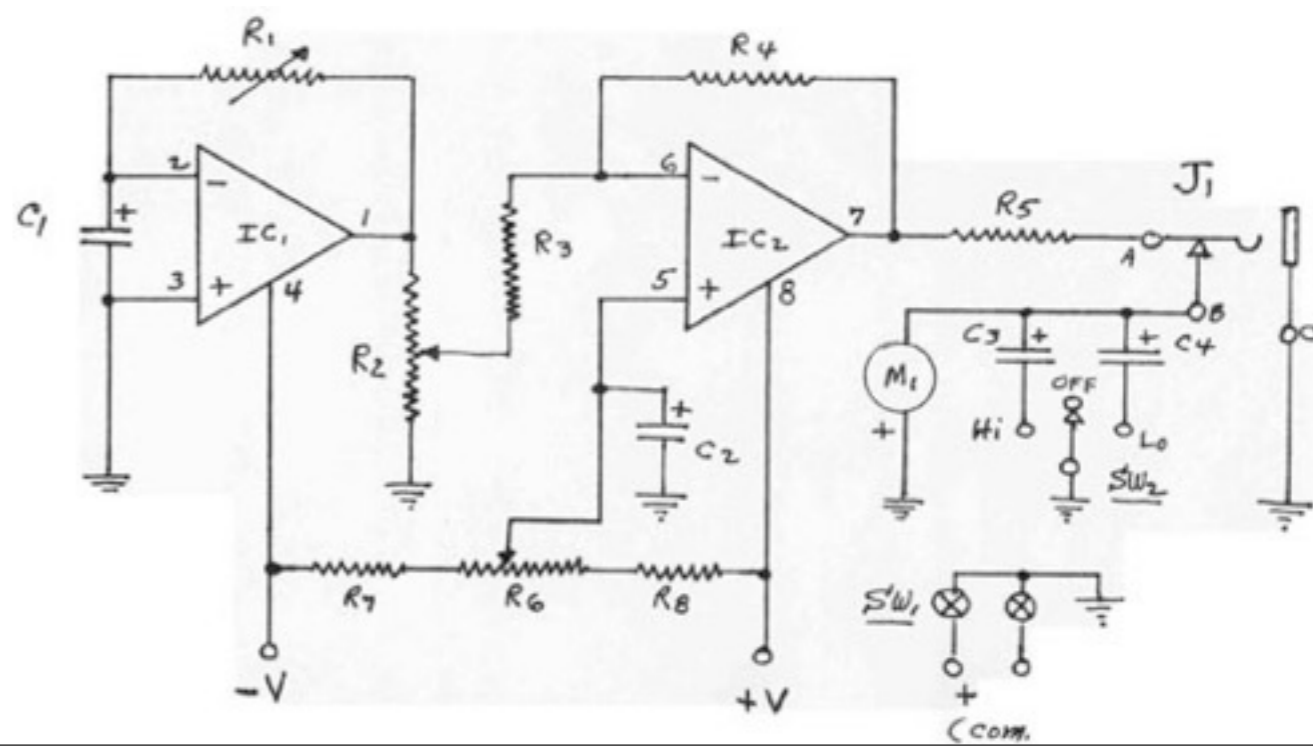

# Real-time ULF and ELF signals as recorded by ELFRAD

This is a plot of ULF transmissions recorded from an antenna array, which detects signals which travel through the earth. The center frequency is 1.618033 hertz with a bandwidth of only .02 hz. This signal which is sometimes called the "Golden Mean or the Fibonacci Sequence", occasionally is detected in high amplitude bursts.

This graph is updated hourly.

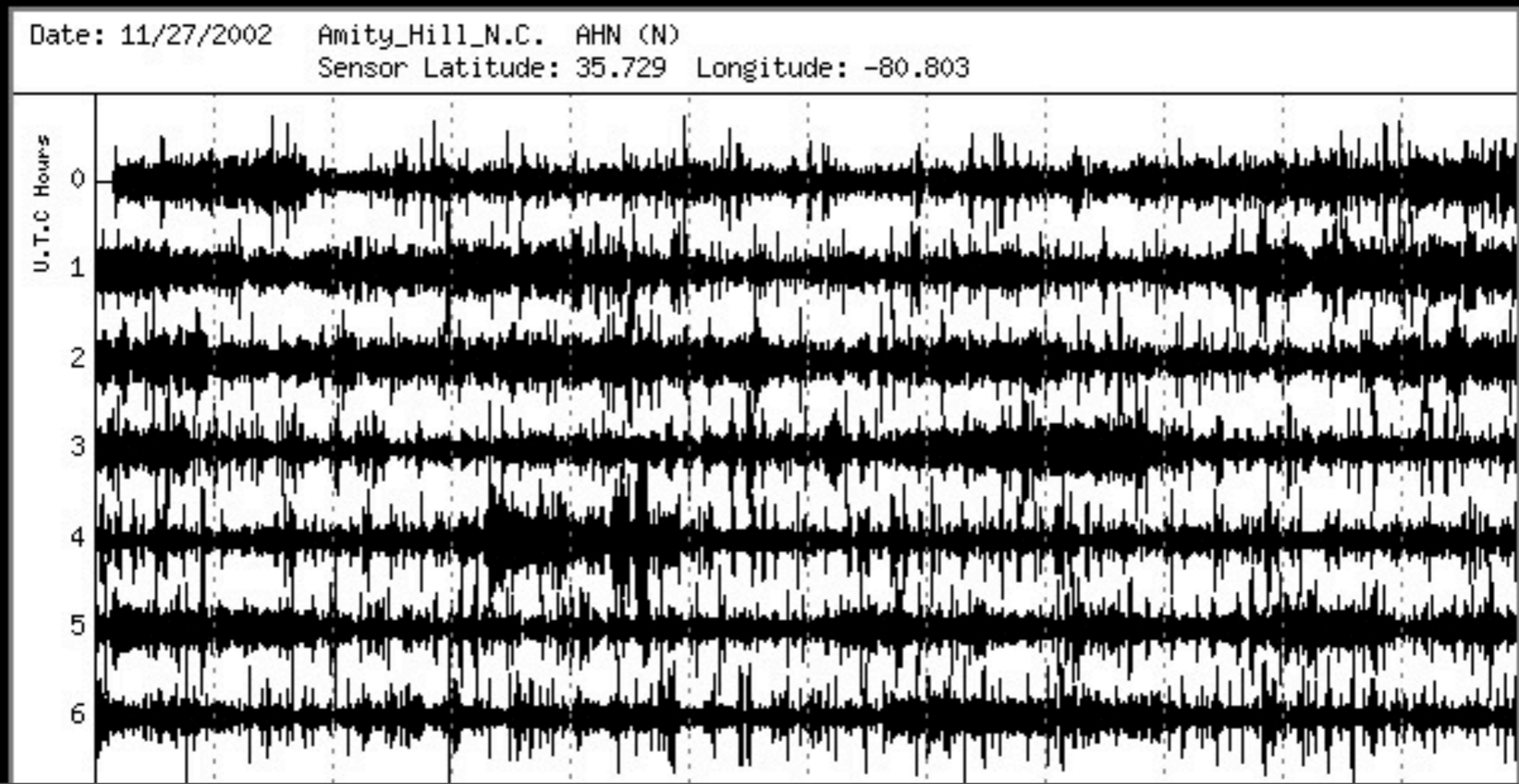

**When Einstein commented that a magnetic monopole (wormhole) WAS the relationship of gravity to charge - he foretold a clue to his own dilemma: WHAT IS THE GEOMETRY OF INFINITE COMPRESSION? He knew THAT geometry WAS the connection of electromagnetism to gravity.**

Compression gravity txt

**Faraday's observed that: 'Electrical capacity is to gravity as inductance is to magnetism'. ....He concluded the energy stored in a capacitor is in the form of a GRAVITATIONAL field.**

**Townsend Brown also found in charged capacitors that weight reduction only occurs when the positive plate is upside to the negative plate. .... If the negative plate is above then the device inceases in weight . Dan Davidson et al then observed that the AMOUNT of weight change is greatest if a SMALLER CAPACITOR is nested under the larger!?. The obvious next experiment is to nest capacitors in the (Golden) ratio of recursion/embedding, to PRODUCE OPTIMUMCHARGE COMPRESSION & THEREFORE THE GREATEST GRAVITY!#(Capacitors in Phi array - produce 'ion effect')**

**To solve the unified field, understand the geometry of compression.**

**Compressing charge stores the inertia of that charge, which physics then calls 'mass'.**

**Waves use PHI recursion to send a portion of that inertia thru light speed at the implosion center, to produce the magnetic monopole which was Einstein's name for gravity. Like pulling The drain in the bathtub - a way out thru light speed creates the wind of charge:gravity.**

**Unified physics: to embed yourself into that vortex wormhole tornado, is the role of mind among waves (why MIND inhabits PHIRE).**

**People lose weight measureably at the instant of death - Radioactive half life is measureably reduced by focused human attention. Restoring the charge fractality keeps a little tornado vortex better centered in a bigger tornado. That centering force IS gravity, and IS the proof that attention IS the creation of charge**